



Shenzhen Maichaoian Technology Co., Ltd.



CORE SERVICE PROVIDER  
CONSUMER ELECTRONICS

# SMART GLASSES

## Catalog

A technology company focused on the research, development, production, and sales of consumer electronics products such as smart wearables and AI smart glasses.

01

Company Profile

Whatsapp: +86 150 13663593

Address: Room 3A, Ye'an Building, No. 188 Zhen'an West Road, Chang'an, Dongguan, China

02

Production Environment

EM: info@mclgear.com

03

Product Display

Web: www.mclgear.com

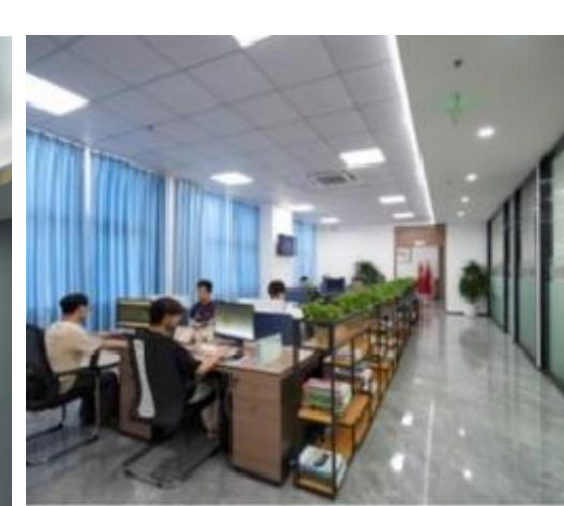

## ABOUT US

**Shenzhen Maichao Lian Technology Co., Ltd.** was established in Shenzhen in 2012. Over more than ten years of development since its founding, MCL has grown into a technology company focused on the design, production, sales, and after-sales service of 3C electronic products and smart wearable devices.

### Inspiration

The Shenzhen Maichaolian team's vision is to create an unprecedented platform – an online marketplace that connects makers and their work with people looking for truly special goods, unrestricted by the physical distance between makers and shoppers.

### Survive

Of course, in the struggle to build a viable business, there will always be bumps along the way. We encountered many unexpected difficulties, but persisted...

### Sustainable

Our focus is on building long-term businesses. We have been committed to creating a sustainable business in all aspects, such as product optimization, creative design, customer experience, pre-sales and after-sales services, and selecting high-quality logistics and transportation...

### Evolution

In addition to sustainability, supporting creativity is also very important to us. In addition, we have an in-house product development team that strives to create new products that will surprise even seasoned design fans.

### A Great Future

As we enter a new era of business, we will continue to focus on our commitment to sustainability and creative design. We will never stop working to provide our customers with a great shopping experience.

We have a feeling the future is going to be great.



## Production Environment

## Finished Product Assembly



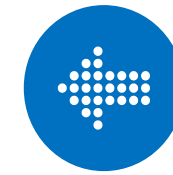

## Full process coverage, worry free and cost-effective

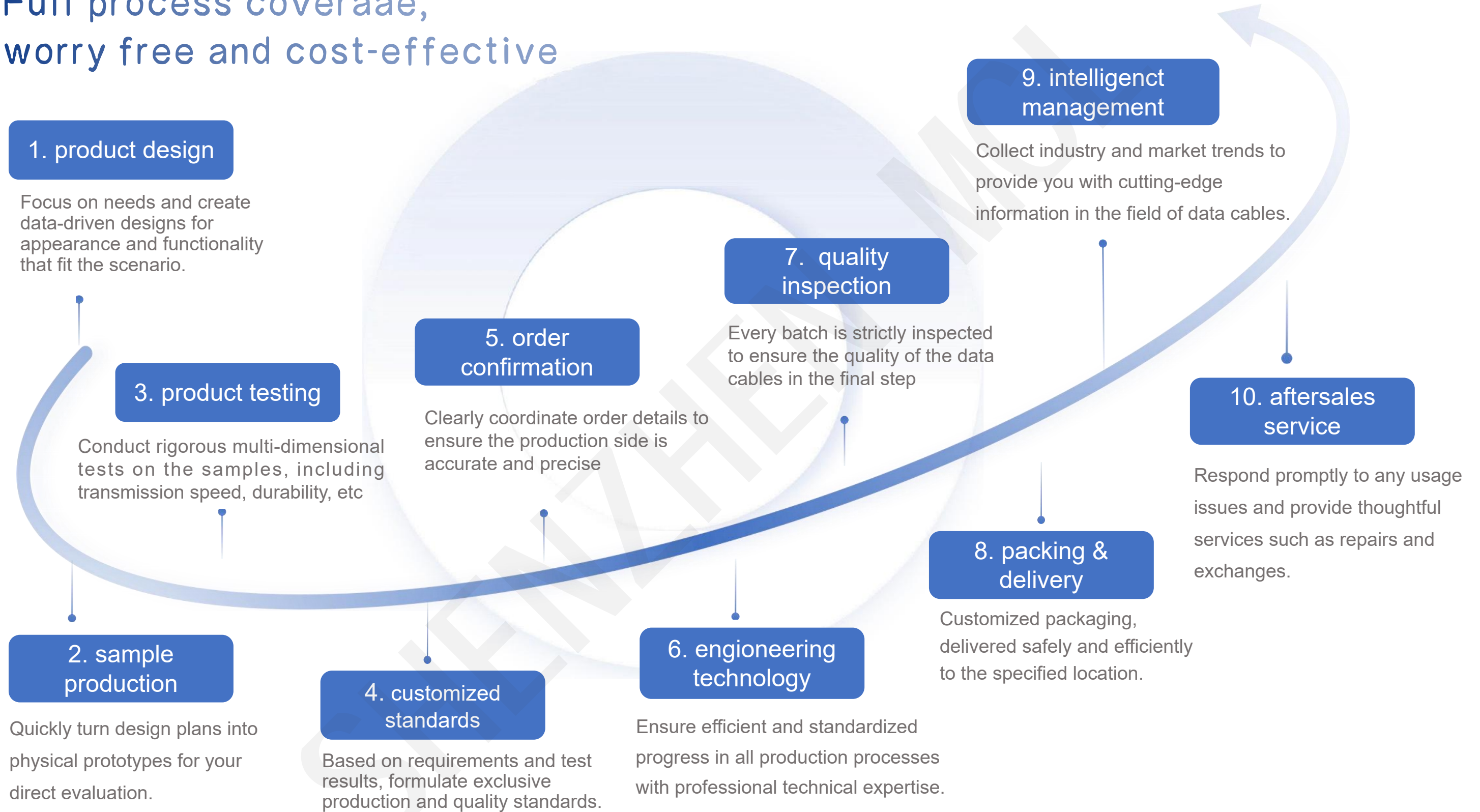

**MODEL: MCL-08**



**12 million pixel AI glasses**

Shooting+real-time translation+voice control



**First-person  
live streaming**



CPU	BES2710Y6Quad-Core Ultra-Low Power
Lens chip	ISP maincontroller 822+Six-axis gyroscope
Hinge	metal hinge
Lens properties	PC(UV400 protection standard)
APP	EveryLink
Pixel	12MP 1080P25fps
Transmission path	WIFI 6 efficient transmission
Store	32GB EMMC storage,
Battery capacity	300mAh high-voltage battery
Speaker unit	13mm Multi-LaverDynamicCojCompositeMembraneSpeaker 8Ω±15%
Waterproof rating	IP67
Indicator light	Status indicator light (white, red, and green)
Working hours	Continue shooting for 1 hour
Music duration	24h (70% volume)
Call duration	18h
Standby time	Standby for45-50 hours, Shut down for about 100 days
Button	physical buttons+Voice wake-up
Charging duration	1-1.5H
System	IOS 13 / Android 9
Model types	Overseas - Chat GPT
Material	TR90&ABS
Weight	38±2g
Color	Black (SunglassLenses, PolaroidPolarized Lenses)
Accessories	Magnetic charging wire, instruction, manual, eyeglass cloth
Language	Multilingual support

# Camera smart glasses ID



**MODEL: MCL-M02 Ultra**

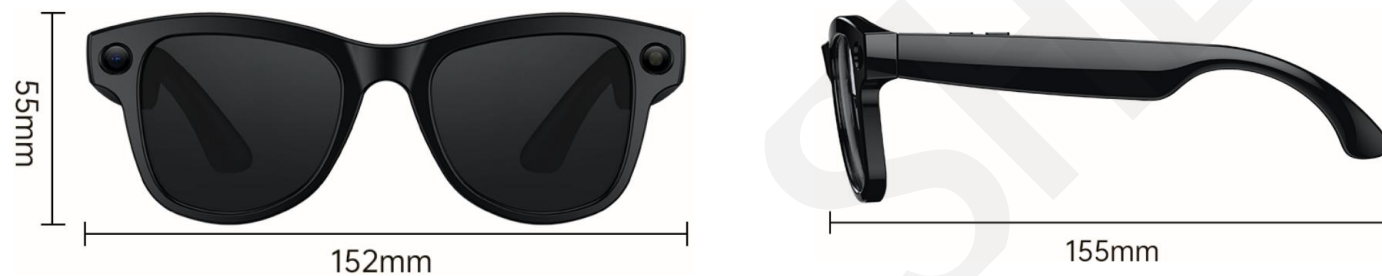

CPU	DualcorearchitectureJL7018F8+V821
Lens chip	Sony IMX219+EISElectronicAntiShake
Hinge	metal hinge
Lens properties	PC(UV400 protection standard)
APP	HeyCyan
Pixel	800W
Transmission path	WIFI 6 efficient transmission
Store	32Gb
Battery capacity	290mAh/3600mAh( can charge your phone)
Speaker unit	13mm 16±1.5%Ω
Waterproof rating	IP67
Indicator light	Blue and red lights
Working hours	≥ 40minutes (Continuous Video recording time)
Music duration	6-7H (70% volume)
Call duration	4-5H
Standby time	Shut down for about 90 days
Button	Touch+physicalbuttons+weardetection+sliding
Charging duration	1-1.5H
System	IOS 13 / Android 9
Model types	Overseas - Chat GPT
Material	ABS+PC
Weight	47±2g
Color	Black,Red, Beige,
Accessories	Magnetic charging wire, instruction manual, eyeglass cloth
Language	Multilingual support

# Camera smart glasses ID



MODEL: MCL-G300C

## Electrochromic lenses instantly stunning

Four adjustable modes, no need to frequently change glasses. You can easily control different lighting environments

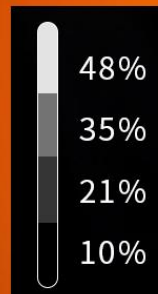

CPU	DualcorearchitectureJL7018F8+V821
Lens chip	Sony IMX219+EISElectronicAntiShake
Hinge	metal hinge
Lens properties	PC(UV400 protection standard)
APP	HeyCyan
Pixel	800W
Transmission path	WIFI efficient transmission
Store	32Gb
Battery capacity	220mAh, supports 3C fast charging
Speaker unit	8Ω±15%
Waterproof rating	IP67
Indicator light	Blue and red lights
Working hours	≥ 40minutes (Continuous Video recording time)
Music duration	Up to 9 hrs (70% volume)
Call duration	4-5H
Standby time	Standby for 48 hours, Shut down for about 90 days
Button	Touch+physicalbuttons+weardetection+sliding
Charging duration	1-1.5H
System	IOS 13/ Android 9
Model types	Overseas - Chat GPT
Material	TR90
Weight	66g
Color	Black (ELECTROCHROMIC LENSES)
Accessories	Magnetic charging wire, instruction manual, eyeglass cloth
Language	Multilingual support

**MODEL: MCL-13**

Electrochromic lenses



Black frame + Gray lenses



White frame + Red mirrored lenses



CPU	BT8961C6+V821L2
Lens chip	Sony IMX219+EISElectronicAntiShake
Hinge	metal hinge
Lens properties	Gray, Red, and Sunglass Lens Options
APP	AIbuds
Pixel	8MP, resolution 3280H*2464V
Transmission path	WIFI efficient transmission
Memory	ROM:16MB RAM:64KB Flash:2Gb
Battery capacity	260mAh(Pure cobalt battery cell),3.8V
Speaker	1508*2
Waterproof rating	IP65
Indicator light	Blue and red lights
Working hours	≥ 40 minutes (Continuous Video recording time)
Music duration	6-7H (70% volume)
Call duration	4-5H
Standby time	Standby for 48-72h, Shut down for about 90 days
Button	Physical button +Touch
Charging duration	About 1.5H
System	IOS 13 / Android 9
Model types	Overseas - Chat GPT
Material	PC+ABS3030
Weight	50±1g
Color	Black,white(Customizable)
Accessories	Charging cable, user manual, dust-free cloth, bag
Language	Multilingual support

# Camera smart glasses ID



**MODEL: MCL-CY01**

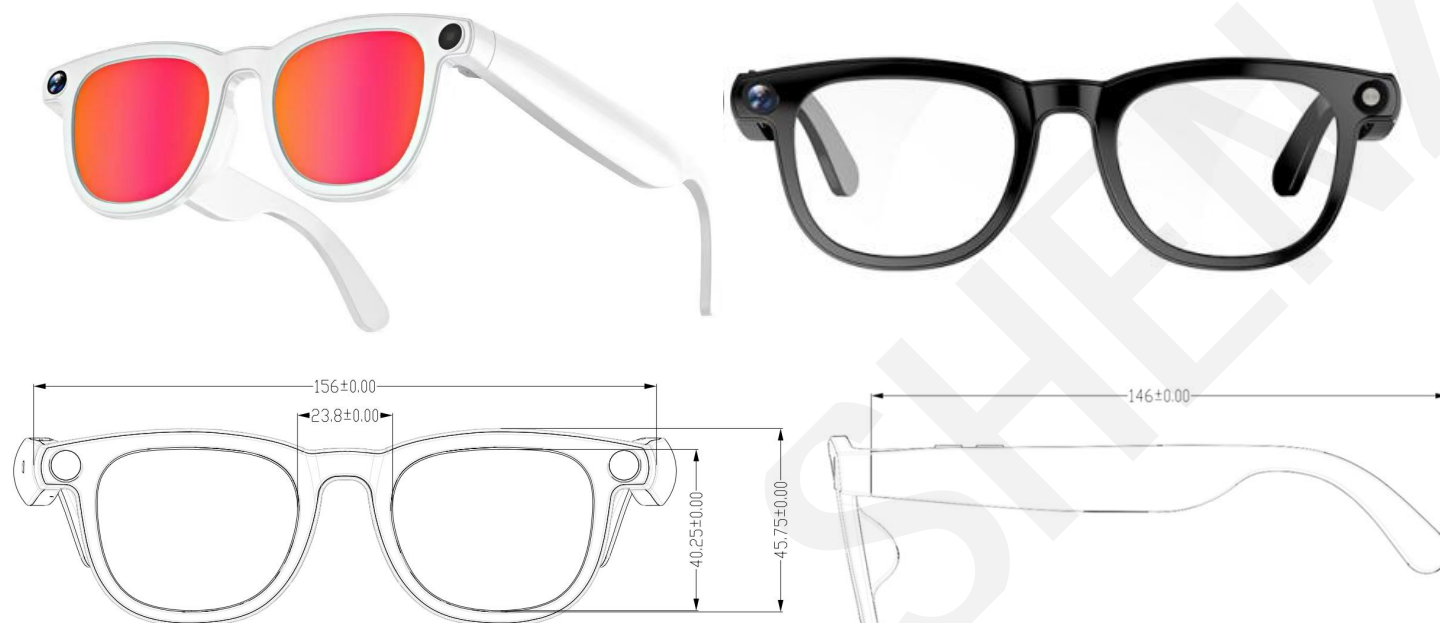

- CPU
- Lens chip
- Hinge
- Lens properties
- APP
- Pixel
- Transmission path
- Store
- Battery capacity
- Speaker unit
- Waterproof rating
- Indicator light
- Working hours
- Music duration
- Call duration
- Standby time
- Button
- Charging duration
- System
- Model types
- Material
- Weight
- Color
- Accessories
- Language

DualcorearchitectureJL7018F8+V821

Sony IMX219+EISElectronicAntiShake

metal hinge

PC(UV400 protection standard)

HeyCyan

800W

WIFI efficient transmission

16Gb

255mAh

0916

IP65

Blue and red lights

≥ 40 minutes (Continuous Video recording time)

6-7H (70% volume)

4-5H

Standby for 48-72h, Shut down for about 90 days

Touch+physicalbuttons+weardetection+sliding

1-1.5H

IOS 13 / Android 9

Overseas - Chat GPT

ABS+PC

37.5±2g

Black,white

Magnetic charging wire, instruction manual, eyeglass cloth

Multilingual support

# Camera smart glasses ID



MODEL: MCL-GJ01



- CPU
- WIFI
- BT
- Lens properties
- APP
- Camera
- Microphone
- ROM/RAM
- Battery capacity
- Speaker
- Waterproof rating
- Indicator light
- Working hours
- Music duration
- Call duration
- Standby time
- Button
- Charging duration
- System
- Model types
- Material
- Weight
- Color
- Accessories
- App Language

JL7018F + GK7202V330 camera SoC  
Wi-Fi two-in-one chip, Supports Wi-Fi 6  
V5.4 + 3.0 low-power consumption  
PC(UV400 protection standard),  
FancyView  
Photo 8MP, Video 1080P  
Dual Microphone ENC Noise Reduction  
ROM: SD NAND 16Gb + RAM: 640kb  
200mAh  
independent 2.0-channel sound chambers for stereo playback  
IP65  
Camera Light +Charging Light  
≥ 30minutes (Continuous Video recording time)  
8-10H(70% volume)  
4-6H  
Daily use 5-7 days, Shut down for about 90 days  
Physical button+Touch  
2-3H, 2Pin magnetic charging  
Support IOS 13+ / Android 9+  
Chat GPT  
TR90  
47.5g  
Glossy black, matte black  
Magnetic charging wire, instruction manual, eyeglass cloth  
Multilingual support

# Camera smart glasses ID



**MODEL: MCL-W610**



Black body with: anti-blue light lenses/sunglasses/discoloration



White body with red coated lens

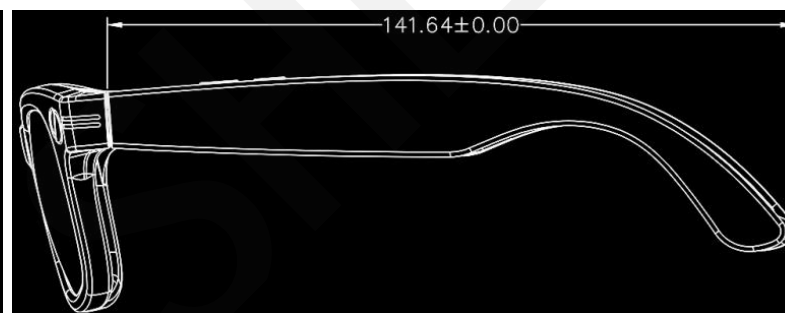
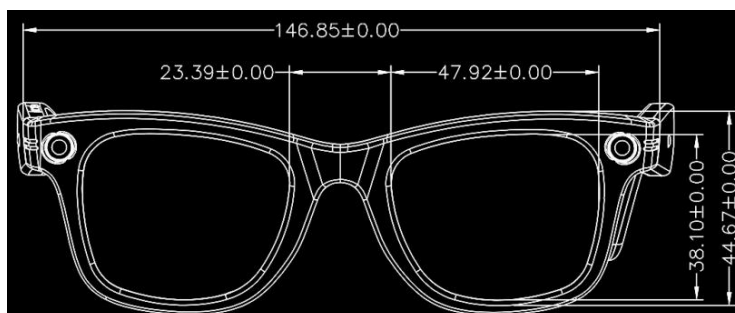

CPU	JL7018F8+V821L2
Lens chip	Sony IMX219+EISElectronicAntiShake
Hinge	metal hinge
Lens properties	PC(UV400 protection standard)
APP	HeyCyan
Pixel	800W(interpolated pixels 32 million)
Transmission path	WIFI efficient transmission
Store	2GB (bit:16Gb)
Battery capacity	Polymer 270mAh
Speaker unit	0916
Waterproof rating	IP65
Indicator light	Blue and red lights
Working hours	≥ 40 minutes (Continuous Video recording time)
Music duration	Play music for about 10 hours (70% volume)
Call duration	6-7H
Standby time	Standby for 48-72h, Shut down for about 100 days
Button	Material buttons combined with touch control
Charging duration	1-1.5H
System	IOS 13 / Android 9
Model types	China - Doubao; Overseas - Chat GPT
Material	TR flexible material with black spray coating
Weight	35±1g
Color	Black /white
Accessories	Magnetic charging wire, instruction manual, eyeglass cloth
Language	Multilingual support

# Camera smart glasses ID



MODEL: MCL-G300



标准款

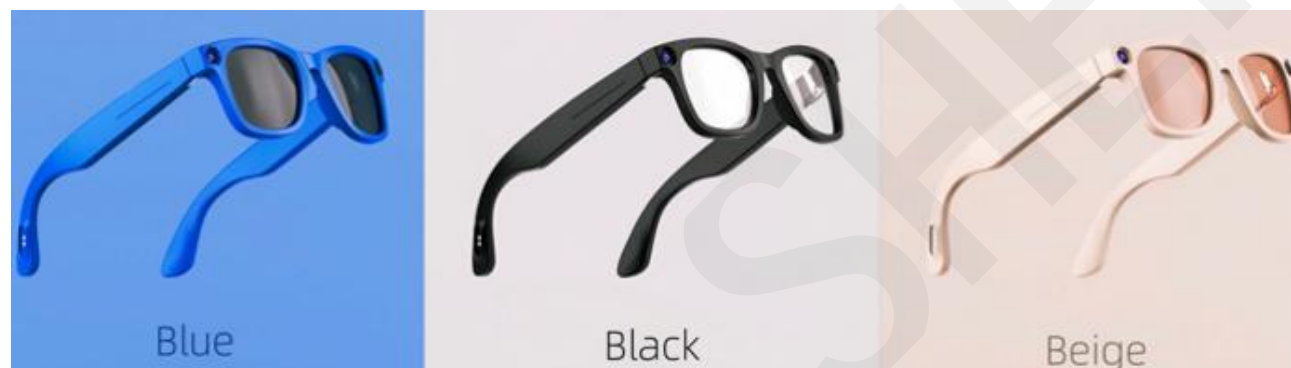

CPU	DualcorearchitectureJL7018F8+V821
Lens chip	Sony IMX219+EISElectronicAntiShake
Hinge	metal hinge
Lens properties	PC(UV400 protection standard)
APP	HeyCyan
Pixel	800W
Transmission path	WIFI efficient transmission
Store	32Gb
Battery capacity	220mAh
Speaker unit	8Ω±15%
Waterproof rating	IP67
Indicator light	Blue and red lights
Working hours	≥ 40minutes (Continuous Video recording time)
Music duration	6-7H (70% volume)
Call duration	4-5H
Standby time	Standby for 48-72h, Shut down for about 100 days
Button	Touch+physicalbuttons+weardetection+sliding
Charging duration	1-1.5H
System	IOS 13/ Android 9
Model types	China - Doubao; Overseas - Chat GPT
Material	ABS+PC
Weight	38±2g
Color	Black/Beige/Blue
Accessories	Magnetic charging wire, instruction manual, eyeglass cloth
Language	Multilingual support

# Camera smart glasses ID



MODEL: MCL-M02C



CPU	DualcorearchitectureJL7018F8+V821
Lens chip	Sony IMX219+EISElectronicAntiShake
Hinge	metal hinge
Lens properties	PC(UV400 protection standard)
APP	HeyCyan
Pixel	800W
Transmission path	WIFI efficient transmission
Store	32Gb
Battery capacity	220mAh.3.8V
Speaker unit	AAC Dual Speakers 0916 / Independent Amplifier
Waterproof rating	IP67
Indicator light	Blue and red lights
Working hours	≥ 40minutes (Continuous Video recording time)
Music duration	8-9H (70% volume)
Call duration	5-6H
Standby time	Standby for 48-72h, Shut down for about 90 days
Button	Touch+physicalbuttons+weardetection+sliding
Charging duration	1-1.5H
System	IOS 13+, Android 9+
Model types	Overseas - Chat GPT
Material	Frame: TR.Temple: PC (painted)
Weight	48±1g
Color	Black
Accessories	Magnetic charging wire, instruction manual, eyeglass cloth
Language	Multilingual support

# Camera smart glasses ID



**MODEL: MCL-W620**

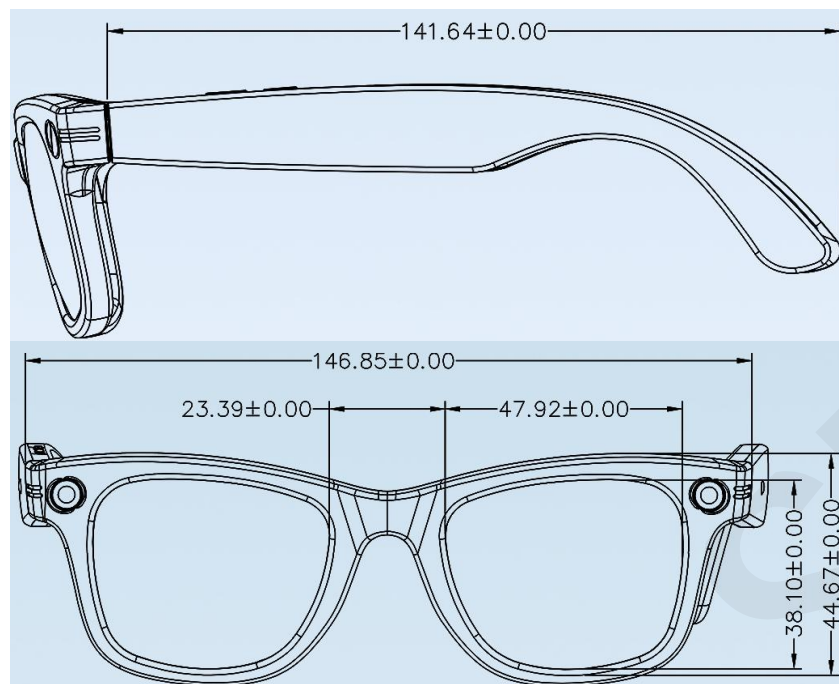

CPU	DualcorearchitectureJL7018F8+V821
Lens chip	Sony IMX219+EISElectronicAntiShake
Hinge	metal hinge
Lens properties	PC(UV400 protection standard)
APP	Da Echo
Pixel	500W
Transmission path	WiFi transmission for photos, videos,and recordings
Store	4GB (Bit: 32G)
Battery capacity	290mAh 4.35V/4.4V
Speaker unit	∅ 12mm
Waterproof rating	IP66
Indicator light	Camera Light +Charging Light
Working hours	≥ 40minutes (Continuous Video recording time)
Music duration	10H (70% volume)
Call duration	5-6H
Standby time	Standby for 48-72h, Shut down for about 100 days
Button	Material button+touch control,
Charging duration	1-1.5H ( Magnetic charging)
System	IOS 13 / Android 9
Model types	Overseas - Chat GPT
Material	TR tough material
Weight	40±2g
Color	Black,white (Multicolored lenses)
Accessories	charging cable, storage bag, glasses cloth, 2 ear pads, user manual
Language	Multilingual support

# Camera smart glasses ID



MODEL: MCL-G3



Matte black model    Matte transparent version

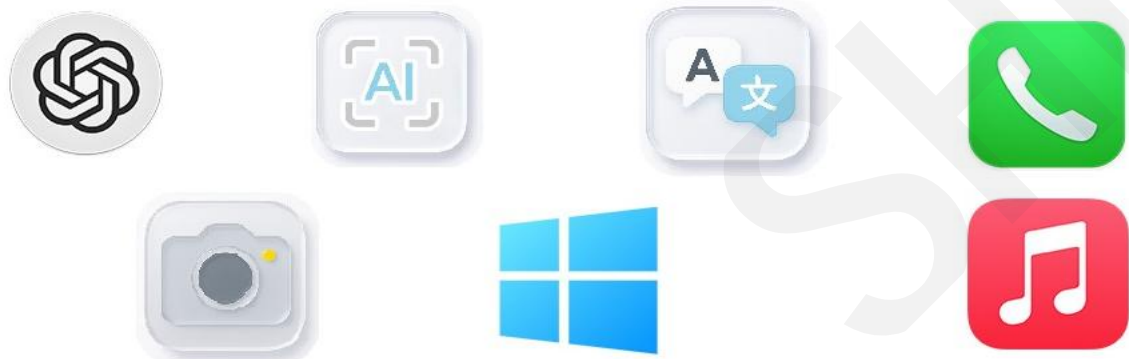

CPU	JL7018F8+V821
Camera	8MP Sony IMX219 sensor
Wifi	support Wi-Fi transmission
Lens properties	changeable lenses*1, grey lenses*1, brown lenses*1
APP	Cyan Glasses
BT Version	V5.3
Mcirophone	Double silicon mic. noise reduction
Store	16Gb
Battery capacity	290mAh, supports 3C fast charging
Speaker	AAC speaker offers both high and low audio quality
Waterproof rating	IP65
Indicator light	Camera Light +Charging Light
Working hours	≥ 40minutes (Continuous Video recording time)
Music duration	7-8H (70% volume)
Call duration	5-6H
Standby time	Standby for 48-72h, Shut down for about 90 days
Button	Physical button+Touch
Charging duration	1-1.5H, Magnetic fast charging
System	IOS 13 +, Android 9+
Model types	Chat GPT
Material	ABS+PC
Weight	42g
Color	Black,white,
Accessories	Charging cable, manual, glasses cloth, lenses *2
Language	Multilingual support

# Camera smart glasses ID



MODEL: MCL-G06



Orange



Blue



Black



CPU

DualcorearchitectureJL7018F8+V821

Lens chip

Sony IMX219+EISElectronicAntiShake

Hinge

metal hinge

Lens properties

PC(UV400 protection standard)

APP

HeyCyan

Pixel

800W

Transmission path

WIFI efficient transmission

Store

32Gb

Battery capacity

260mAh

Speaker unit

∅ 12 Dual Horns

Waterproof rating

IP65

Indicator light

Camera Light +Charging Light

Working hours

≥ 40minutes (Continuous Video recording time)

Music duration

6-7H (70% volume)

Call duration

5-6H

Standby time

Standby for 48-72h, Shut down for about 90 days

Button

Physical button

Charging duration

1-1.5H

System

IOS 13 / Android 9

Model types

Overseas - Chat GPT

Material

ABS+PC

Weight

42g

Color

Black,Blue,Orange

Accessories

Magnetic charging wire, instruction manual, eyeglass cloth

Language

Multilingual support

# Camera smart glasses ID



MODEL: MCL-G11

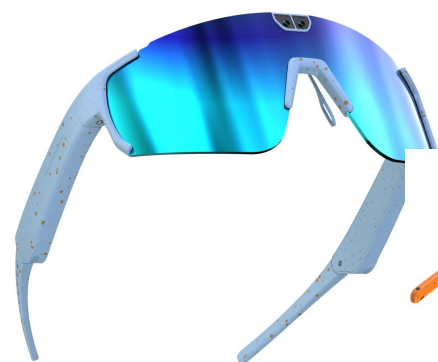

CPU	DualcorearchitectureJL7018F8+V821
Lens chip	Sony IMX219+EISElectronicAntiShake
Hinge	metal hinge
Lens properties	PC(UV400 protection standard)
APP	HeyCyan
Pixel	800W
Transmission path	WIFI efficient transmission
Store	32Gb
Battery capacity	260mAh
Speaker unit	∅ 12 Dual Horns
Waterproof rating	IP65
Indicator light	Camera Light +Charging Light
Working hours	≥ 40minutes (Continuous Video recording time)
Music duration	6-7H (70% volume)
Call duration	5-6H
Standby time	Standby for 48-72h, Shut down for about 90 days
Button	Physical button
Charging duration	1-1.5H
System	IOS 13 +, Android 9 +
Model types	Overseas - Chat GPT
Material	ABS+PC
Weight	42g
Color	Black,Blue,Orange
Accessories	Magnetic charging wire, instruction manual, eyeglass cloth
Language	Multilingual support

# Camera smart glasses ID



MODEL: MCL-Q01



CPU	DualcorearchitectureJL7018F8+V821
Lens chip	Sony IMX219+EISElectronicAntiShake
Hinge	metal hinge
Lens properties	Available in multiple lens colors
APP	HeyCyan
Pixel	800W
Transmission path	WIFI 6 efficient transmission
Store	32Gb
Battery capacity	290mAh
Speaker unit	13mm 16±1.5%Ω
Waterproof rating	IP67
Indicator light	Blue and red lights
Working hours	≥ 40minutes (Continuous Video recording time)
Music duration	6-7H (70% volume)
Call duration	4-5H
Standby time	Shut down for about 90 days
Button	Touch+physicalbuttons+weardetection+sliding
Charging duration	1-1.5H
System	IOS 13 / Android 9
Model types	Overseas - Chat GPT
Material	ABS+PC
Weight	45±1g
Color	Black
Accessories	Magnetic charging wire, instruction manual, eyeglass cloth
Language	Multilingual support

# Camera smart glasses ID



MODEL: MCL-Y01

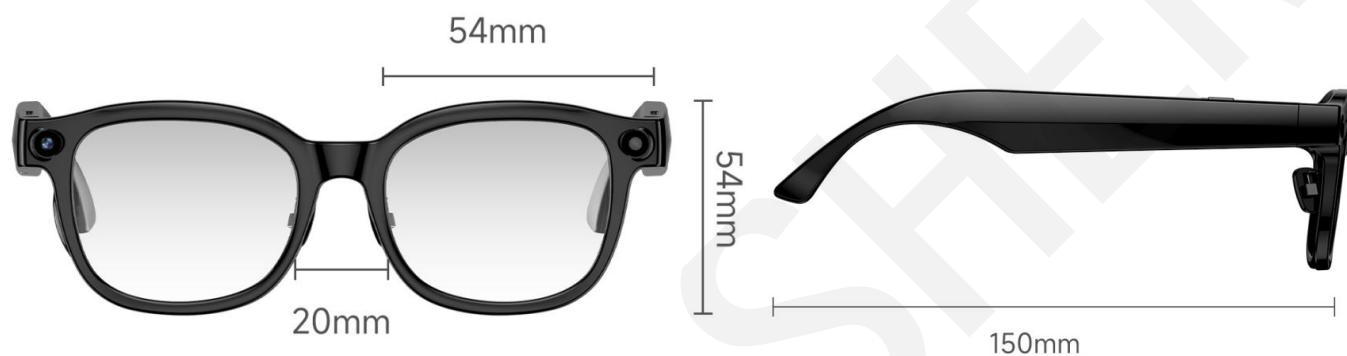

CPU	DualcorearchitectureJL7018F+V821
Lens chip	Sony IMX219+EISElectronicAntiShake
Hinge	metal hinge
Lens properties	PC(UV400 protection standard)
APP	Da Echo
Pixel	8MP (with interpolated imaging pixels up to 20MP)
Transmission path	WIFI efficient transmission
ROM	4GB (bit:32G)
Battery capacity	285mAh
Speaker unit	∅ 12mm
Waterproof rating	IP65
Indicator light	Camera Light +Charging Light
Working hours	≥ 40minutes (Continuous Video recording time)
Music duration	8-9H(70% volume)
Call duration	5-6H
Standby time	Standby for 48-72h, Shut down for about 100 days
Button	Physical button
Charging duration	1-1.5H
System	IOS 13 / Android 9
Model types	China - Bean Bun Overseas - Chat GPT
Material	ABS+PC
Weight	42g
Color	Black,Brown
Accessories	Magnetic charging wire, instruction manual, eyeglass cloth
App Language	Multilingual support

MODEL: MCL-XV20

## Smart Bluetooth Audio Glasses

Waterproof and dustproof/music playback/long-lasting battery life



Anti sunlight lenses



Multi device seamless



**Product name** :smart DV glasses

**Bluetooth** : jieli V5.3

**Transmit distance** :15-20m

**Battery capacity** :400mAh

**Talking time** :48H

**Charging time** : 1-2H

**Video** :1080P / 30 frames

**Video difinition** : 1920\*1080 200W avi

**Pic definition** : 1920\*1080 JPG

**TF card** : 2gb-128gb

**Memory** : 32GB TF card ( more memory , discuss )

**OTG**: support

**Pc to camera** : yes

**Video while charging** : yes

**Charging port** : type -C

**App** : Nebulabuds

**App function** : translation ,recording , ai dialogue ,AI .

# Audio smart glasses ID



**MODEL: MCL-GV90**



Smart Dimming  
and  
Color-Changing  
Glasses



<b>Functions</b>	Bluetooth call / Music playback / Voice assistant / Remote control photo taking / AI translation
<b>USE CASE</b>	Drive、 Fishing 、 Travel Business、 Daily
<b>LENS EFFECT</b>	UV protection / UV400 / Anti-glare
<b>Main control chip</b>	AB5632B
<b>Battery</b>	150mA
<b>Charging way</b>	Magnetic charging
<b>Bluetooth version</b>	BLE5.4
<b>Bluetooth protocol</b>	A2DP,HFP
<b>Mode of operation</b>	Button
<b>Transmission distance</b>	10M
<b>Waterproof level</b>	Life waterproof
<b>Material</b>	ABS+PC
<b>Voltage</b>	DC5V
<b>Water Proof</b>	IPX5
<b>Electric current</b>	120mA
<b>Play current (max volume)</b>	38mA
<b>Standby current</b>	6mA
<b>Lens Material</b>	Liquid crystal glass lens
<b>Size</b>	180*84*64mm
<b>Weight</b>	Glasses44g + packing box 171g =215g
<b>Outer box specifications</b>	430mm×375mm×333mm 50pcs/11.35KG
<b>Language</b>	English

MODEL: MCL-TX06



Battery is replaceable

The battery swapping method is patented

### Bluetooth glasses parameters

<b>Bluetooth Version</b>	V5.3	
<b>Bluetooth Chip Model</b>	BT8926b	
<b>Paired name</b>	TX06	
<b>Bluetooth Profile</b>	HFP、A2DP、AVRCP	
<b>Wireless Range</b>	>10m	
<b>Play Music Time</b>	4h (Phone Volume 80%)	
<b>Talk Time</b>	3.5h (Volume 80%)	
<b>Shutdown Current</b>	<18uA	
<b>Standby Current</b>	10mA	
<b>Operating Current</b>	15mA ~ 25mA	
<b>Operating Voltage</b>	3.2V ~ 4.2V	
<b>Shutdown Voltage</b>	3.2V	
<b>Detachable Battery</b>	<b>Type</b>	Polymer Lithium Battery
	<b>Capacity</b>	70mAh
	<b>Size</b>	18mm*10mm*5mm
	<b>Nominal Voltage</b>	3.7V
	<b>Charging current</b>	40mAh ~ 200mAh
	<b>Charging Time</b>	1.7h
<b>Bluetooth Glasses Weight</b>	42g	

### Charging case parameters

Parameters	Specification
<b>Type</b>	Polymer Lithium Battery
<b>Capacity</b>	520mAh
<b>Nominal Voltage</b>	3.7V
<b>Charging current</b>	500mA±10%
<b>Charging Time</b>	1.5h
<b>Full charge voltage</b>	4.15V ~ 4.2V
<b>Charge Input Voltage</b>	5V/1A
<b>Charge Input Interface</b>	TYPE-C USB
<b>Charge Output Interface</b>	Copper column contact
<b>Charge-discharge Characteristic</b>	Supports charging while discharging
<b>Charge Times</b>	3 Times
<b>Charging Case Weight</b>	35g

# Audio smart glasses ID



MODEL: MCL-HY02



<b>Material of product</b>	Electroplated Alloy Frame, Grade A Nylon Lenses
<b>Track system</b>	Stereo
<b>The control mode</b>	Touch method
<b>Active passive</b>	Active
<b>Bluetooth solutions</b>	AB5656C
<b>Bluetooth version</b>	Bluetooth V5.4
<b>Support Bluetooth profile</b>	HFP HSP A2DP AVRCP
<b>Bluetooth working frequency</b>	2.402GHz-2.480GHz
<b>TYP</b>	≤ - 90dBm
<b>Bluetooth range</b>	8-15米(straight-line distance)
<b>Speaker Power</b>	Rated Power: 3mW; Maximum Power: 5mW
<b>RF power level</b>	Class2
<b>Power amplifier type</b>	Built-in chip
<b>S/N</b>	≥90dB
<b>frequency response</b>	20Hz ~ 20KHz
<b>Speaker type</b>	Φ10mm PU+LCPComposite film speaker
<b>MIC Sensitivity</b>	-42dB±3dB, Silicone microphone
<b>Battery</b>	-3.7V/90mAh*2
<b>Music time</b>	6-8H
<b>Talk time</b>	6-8H
<b>Charging input criteria</b>	5V / 1A
<b>Charging method</b>	Magnetic charging
<b>Charging time</b>	about 1-2h
<b>Battery cycle life</b>	Charge-discharge cycles ≥ 300 times
<b>Temperature range</b>	Operating: 0~40°C, Storage: -10~45°C
<b>Color</b>	As shown, available in multiple colors
<b>Size</b>	52-20-150mm
<b>Net weight</b>	41±0.5g

MODEL: MCL-TX08



Feature	Operation/Instructions
<b>Bluetooth pairing name</b>	MCL-TX08
<b>Bluetooth Chip Model</b>	BT8926
<b>Bluetooth Profile</b>	HFP、A2DP、AVRCP
<b>charging time</b>	About 70 min
<b>Wireless Range</b>	> 10m
<b>Battery capacity</b>	3.8V 85mAh
<b>Bluetooth version</b>	V5.4
<b>Duration of music playback</b>	5 ~ 6 h (Phone Volume 80%)
<b>Talk Time</b>	3.5-4 h (Volume 80%)
<b>Power on/off</b>	Long press the touch key for 3 seconds
<b>Temple TWS pairing</b>	Double-click the left/right touchpad of the glasses.
<b>Volume up</b>	Tap the touch key on the right side of the glasses three times.
<b>Volume down</b>	Tap the left touch button on the glasses three times.
<b>Play/Pause</b>	Single-click the left/right touchpad of the glasses.
<b>Previous song</b>	Double-click the touch button on the left side of the glasses.
<b>Next song</b>	Double-click the touch button on the right side of the glasses.
<b>answer the phone</b>	Single-click the left/right touchpad of the glasses.
<b>Reject the incoming call</b>	Long press the left/right touch key on the glasses for 1 second
<b>Hang up</b>	Single-click the left/right touchpad of the glasses.
<b>Wake up the phone's voice assistant</b>	Four taps on the left/right touchpad of the glasses

# Audio smart glasses ID



MODEL: MCL-X01



<b>Model</b>	MCL-X01
<b>Bluetooth match name</b>	AT100
<b>Bluetooth version</b>	5.4v
<b>Chipset</b>	BLUETRUM 5756C
<b>Speaker</b>	F10,P+LCP
<b>Control method</b>	Touch control + single tap touch
<b>Dual microphones</b>	Dual microphones for noise reduction and anti-interference
<b>Battery life</b>	8-9 hours (at 60% volume)
<b>Battery Type</b>	High-density polymer lithium battery
<b>Battery Capacity</b>	3.8V.100mAh*2
<b>Waterproof level</b>	IP54
<b>Bluetooth effective distance</b>	<10m
<b>Charging Time</b>	About 1.5h
<b>Charging type</b>	Magnetic charging
<b>Connection method</b>	Bluetooth
<b>Color</b>	Black body with: Anti-blue light lenses / Sunglasses UV400 standard / Photochromic, a total of three types, (detachable, can be customized with other lenses such as myopia)
<b>Material</b>	Frame: TR tough material + spray black Temples: PC tough material + spray black
<b>Special features or selling points</b>	Play music, Call function. Double - click the right temple touch key to enter the voice assistant and click to exit. Offline camera function: When the mobile phone camera is on, long - press the left temple touch key for 2 seconds to take a photo (for some mobile phones, single - click the left/right temple touch key to take a photo).
<b>AI translation</b>	Support different translation APP
<b>Size</b>	150*148*4.7mm
<b>Packing list</b>	glasses,Cable ,cloth bag, glasses cloth,user manual, giftbox
<b>Weight</b>	glasses:38g , giftbox :190g

# Audio smart glasses ID



MODEL: MCL-SG60



<b>Material</b>	ABS+PC
<b>Sound channel system</b>	Wireless stereo sound
<b>Manipulation Mode</b>	touch+key
<b>Waterpooof Level</b>	IP 4
<b>PPG Ship</b>	JL7016C8
<b>Connect Parameter</b>	V5.4
<b>Compatible System</b>	HFP、 A2DP、 AVRCP、 HSP BR+EDR+BLE
<b>operating frequency</b>	2.4GHZ-2.48GHZ ISM Band
<b>distance</b>	≥10 meters
<b>Horn power</b>	30mW
<b>Earphone power amplifier type</b>	MIX8013
<b>Response of frequency</b>	100Hz~10kHz
<b>horn</b>	16ohms electric 1509
<b>Microphone</b>	Silicon label
<b>battery</b>	Lithium ion polymer battery 3.7V 500945 capacity: 220mAh
<b>Current of charge</b>	160MA
<b>Charging time:</b>	1h40min
<b>Saturation voltage:</b>	4.2V±0.05
<b>Static power consumption:</b>	3uA
<b>Standby power consumption:</b>	≤20MA
<b>Running time:</b>	5 H Note: Maximum volume
<b>Shutdown standby time:</b>	6 months
<b>Over discharge protection:</b>	3.3V±0.05
<b>Packing</b>	Glasses, charging cable, glasses cloth
<b>Product NW/PCS</b>	30 g

# Audio smart glasses ID



MODEL: MCL-A01



## sunglasses

Vacation/Driving/  
Outdoor



## Anti blue light

Workplace/Business



## name

Smart Bluetooth Glasses

## model

A01

## Bluetooth version

V5.3

## Effective distance

12m

## weight

24.4g (lens+frame)

## Battery capacity

90+90 mAh

## charging time

About 70 minutes

## standby time

About 150 hours

## call duration

About 6 hours  
(playback duration after  
opening the mirror legs)

## Glasses material

Frame+ultra tough  
PC (temple frame)

MODEL: MCL-SG23



<b>Material</b>	ABS+PC
<b>Sound channel system</b>	Wireless stereo sound
<b>Manipulation Mode</b>	touch
<b>Waterpfoof Level</b>	IP 4
<b>PPG Ship</b>	AB5756C
<b>Connect Parameter</b>	V5.4
<b>Compatible System</b>	HFP、 A2DP、 AVRCP、 HSP BR+EDR+BLE
<b>operating frequency</b>	2.4GHZ-2.48GHZ ISM Band
<b>distance</b>	≥10 meters
<b>Horn power</b>	30mW
<b>Earphone power amplifier type</b>	AXS2033
<b>Response of frequency</b>	100Hz~10kHz
<b>horn</b>	16ohms electric 1509
<b>Microphone</b>	Silicon label
<b>battery</b>	Lithium ion polymer battery 3.7V 400735 capacity: 2 * 80MA
<b>Current of charge</b>	60MA
<b>Charging time:</b>	2h
<b>Saturation voltage:</b>	4.2V±0.05
<b>Static power consumption:</b>	14uA
<b>Standby power consumption:</b>	≤3MA
<b>Running time:</b>	7 H
<b>Shutdown standby time:</b>	6 months
<b>Over discharge protection:</b>	3.3V±0.05
<b>Packing</b>	Glasses, charging cable, glasses cloth
<b>Product NW/PCS</b>	30 g

MODEL: MCL-SG13

Anti blue light smart glasses

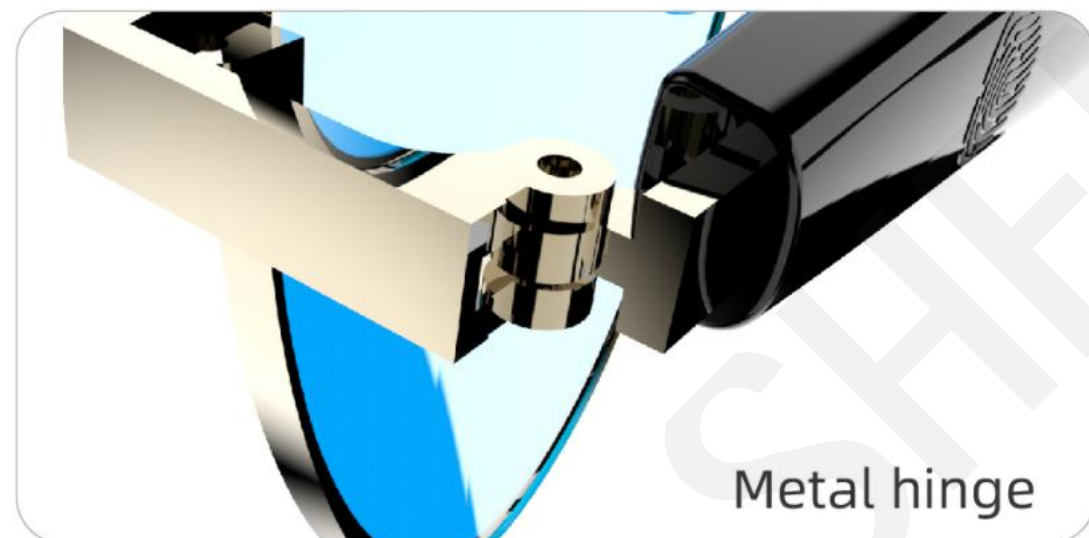

<b>Material</b>	ABS+PC
<b>Sound channel system</b>	Wireless stereo sound
<b>Manipulation Mode</b>	touch
<b>Waterproof Level</b>	IP 4
<b>PPG Ship</b>	AB5756C
<b>Connect Parameter</b>	V5.4
<b>Compatible System</b>	HFP、A2DP、AVRCP、HSP BR+EDR+BLE
<b>operating frequency</b>	2.4GHZ-2.48GHZ ISM Band
<b>distance</b>	≥10 meters
<b>Horn power</b>	30mW
<b>Earphone power amplifier type</b>	AXS2033
<b>Response of frequency</b>	100Hz~10kHz
<b>horn</b>	16ohms electric 1509
<b>Microphone</b>	Silicon label
<b>battery</b>	Lithium ion polymer battery 3.7V 400735 capacity: 2 * 80MA
<b>Current of charge</b>	60MA
<b>Charging time:</b>	2h
<b>Saturation voltage:</b>	4.2V±0.05
<b>Static power consumption:</b>	14uA
<b>Standby power consumption:</b>	≤3MA
<b>Running time:</b>	7 H
<b>Shutdown standby time:</b>	6 months
<b>Over discharge protection:</b>	3.3V±0.05
<b>Packing</b>	Glasses, charging cable, glasses cloth
<b>Product NW/PCS</b>	30 g

MODEL: MCL-F01



Extremely  
cost-  
effective

Material	TR900
Sound channel system	Wireless stereo sound
Manipulation Mode	touch
Waterpfoof Level	IP 4
PPG Ship	AB5616
Connect Parameter	V5.3
Compatible System	HFP、A2DP、AVRCP、HSP BR+EDR+BLE
operating frequency	2.4GHZ-2.4835GHZ ISM Band
distance	≥10 meters
Horn power	1.2W
Earphone power amplifier type	ANT8112
Response of frequency	20~20000Hz
horn	8 ohms electric 0916
Microphone	Electret capacitor microphone
battery	400735 80MA
Current of charge	60MA
Charging time:	2h
Saturation voltage:	4.2V±0.05
Static power consumption:	6UA
Standby power consumption:	≤6MA
Running time:	7 H
Shutdown standby time:	6 months
Over discharge protection:	3.3V±0.05
Packing	Glasses, charging cable, glasses cloth
Product NW/PCS	30 g



MODEL: MCL-SG70

To be updated



# THANK YOU

## *Contact us*

*You can feedback your questions to us using the form below*



WhatsApp



WeChat

Whatsapp: +86 150 13663593

EM: [info@mclgear.com](mailto:info@mclgear.com)