



## Product Range

1 Cleanroom Consumables

2 ESD Equipment & Consumables

3 Personal Protective Equipment

4 New Energy Equipment

**Suzhou Honbest Group-Suzhou Leader Network Technology Co., Ltd**

**Tel : 86-512-57126641**

**Fax : 86-512-55123209**

**Address : No.999, Xueyua Road, Bacheng Town, Kunshan Jiangsu Province,China**

**Website : [www.honbestesd.com](http://www.honbestesd.com)**

# Cleanroom Wiper

Cleanroom Wiper are made from 100% polyester fiber or 80% polyester and 20% nylon with double knitting, laser or ultrasonic cutting technology, generating no fiber or particle. Ultra pure water system maintains the highest clearness and purity. Washed and packed in class 10 (ISO 4) environment.

## • Polyester Wiper



**Features:**

- ① Cost-effective solution
- ② Good absorbing capacity
- ③ Low particle generation
- ④ Double packed in Class 100~1000 environment

**Applications:**

Semiconductor TFT-LCD  
Cell phone module line PCB Industry

Part Name:	Polyester Wiper (100% Polyester)
Size :	4"*4"/ 6"*6"/ 9"*9"/ 12"*12"
Product Remark:	SGS ROHS
Product Kind:	100pcs/bag or 400pcs/bag or 1200pcs/bag or customized packed

## • Micro Fiber Wiper



**Features:**

- (1) Excellent wiping without scratches
- (2) Extremely low non-volatile residues and ions
- (3) Excellent absorbing capacity
- (4) Suitable for sensitive surface by its soft texture
- (5) Double packed in Class 10~100 Cleanroom

**Applications:**

Sophisticated products  
Digital camera lens  
Printer drum or TFT-LCD, PDA

Part Name:	80% polyester and 20% nylon with double knitting, laser or ultrasonic Cutting
Size :	4"*4"/ 6"*6"/ 9"*9"/ 12"*12"
Product Remark:	SGS ROHS
Product Kind:	100pcs/bag or 400pcs/bag or 1200pcs/bag or customized packed



## • Cleanroom Wiper

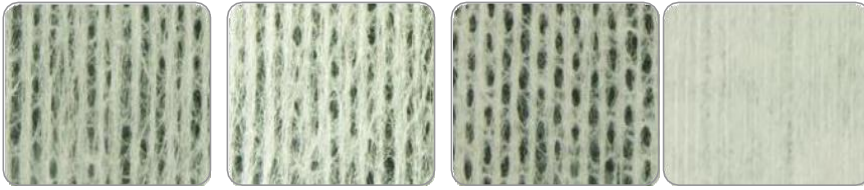

Item Code/Parts No.		M-3		M-3		M-3		0609 Serial	
General Information									
Weight	g/m <sup>2</sup>	30	±3	30	±3	35	±3	56/60/68	±3
Thickness	mm	0.25	±0.02	0.25	±0.02	0.3	±0.02	0.264	±0.02
Width	mm	250	±2	250	±2	250	±2	230 (9")	±2
Length	mm	250	±2	250	±2	250	±2	230 (9")	±2
Compositions	%	Rayon 70 Polyeter30		Rayon 100		Rayon 1-6 Polyester 99-94		Polyester 45 Cellulose 55	
Standard Packing		100pcs/bag 30bags/carton		100pcs/bag 30bags/carton		100pcs/bag 30bags/carton		300pcs/bag 10bags/carton	

## • Production Application

- ① Wiping Cleanroom, Optics Instrument, Electronic, Apparatus, Precision Instruments.
- ② Cleaning Appliance and Instrument in Fiber Manufacturing and Laboratory.
- ③ Cleaning Machine in Food Processing, Printing and Packaging Industry
- ④ Cleaning Oil, Water, Dust and Chemical reagent on Parts and Tools.
- ⑤ Wiping the Untensils and Tops of the Lab, Kitchen etc.
- ⑥ Wiping and Maintaining the Mechanical Equipments.
- ⑦ Cleaning the Transmission Belts and Rollers.



## • Fabric & Cleanroom Garment

ESD/Cleanroom Fabrics are primarily composed of high multi-filament polyester and carbon filament yarn to insure maximum protection against particle contamination and ElectroStatic Discharge (ESD).

The fabrics did not neglect to consider the salient concerns of the workers including air permeability, wearability and durability.

Product Name:	Anti static fabric
Style	Grid/Plain
Material:	2.5mm, 5mm 99%Polyester fiber+1% conductive fiber 1/2 Twil
Color	White,blue,yellow,green,pink,grey or customized co c
Surface resistance	10e6-10e9
Weight:	115g/m <sup>2</sup>
Width	1.5m

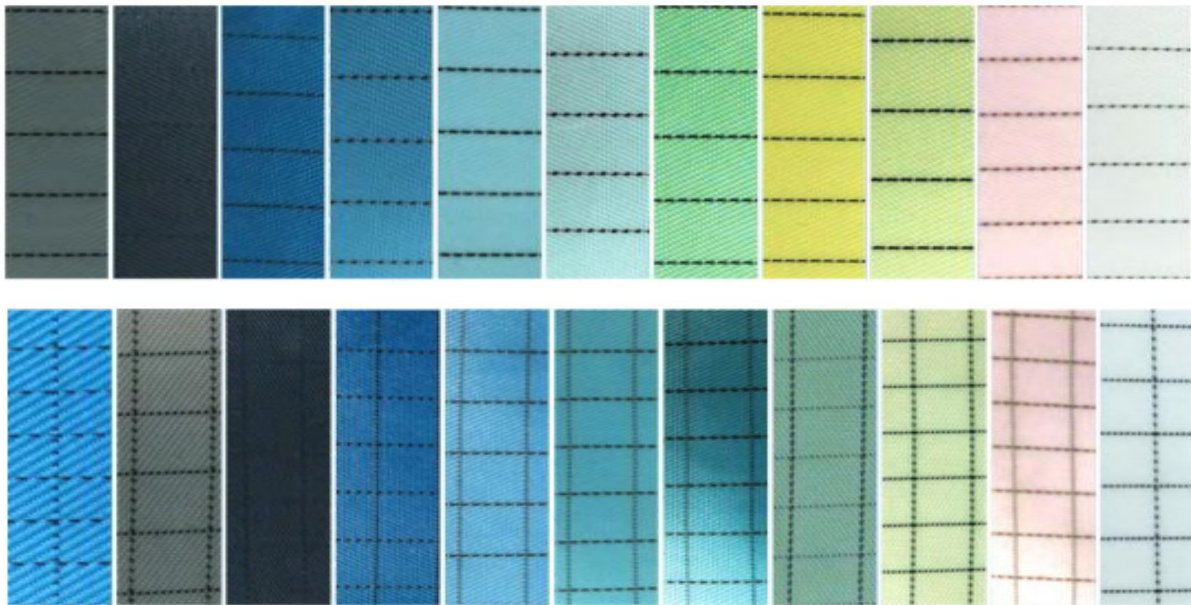

### Advantages

- ⑤ Different fabrics
- ⑥ Can be satisfied to more color choosing
- ⑦ Strict quality control from our profound knowledge and wide experience
- ⑧ Continuous development to meet customer's new requirement
- ⑨ Additional treatments, such as silicon free, teflon and antimicrobial, are available.

### Applications

- ⑩ Electronic and semiconductor Industries
- ⑪ Medical and Pharmaceutical
- ⑫ Food Industry
- ⑬ Paint Industry
- ⑭ Aerospace ndustry

• Fabric & Cleanroom Garment

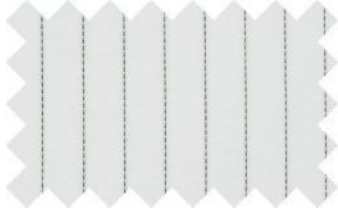
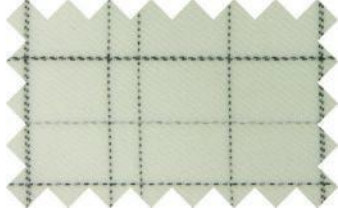
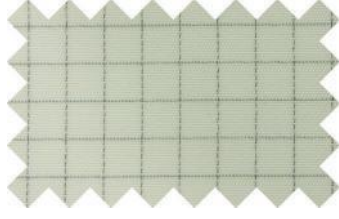
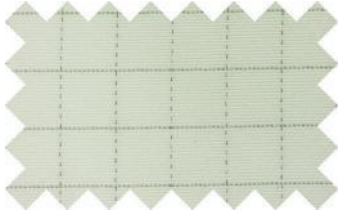
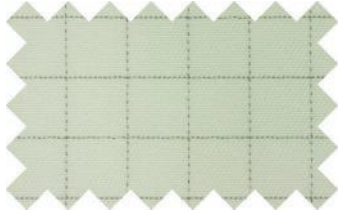
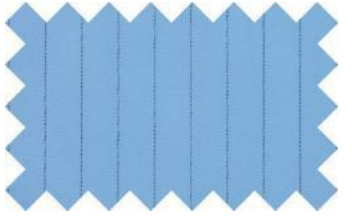
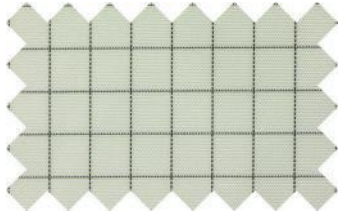
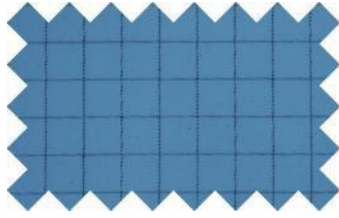
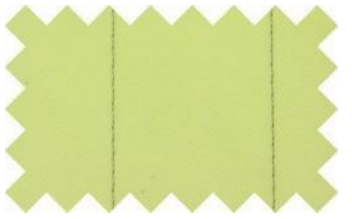
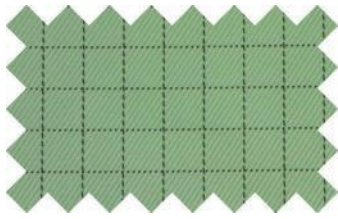
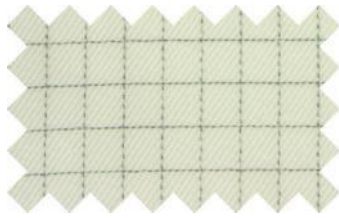
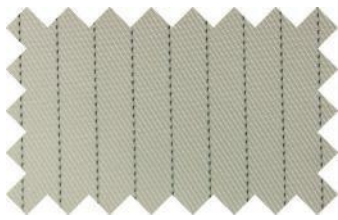
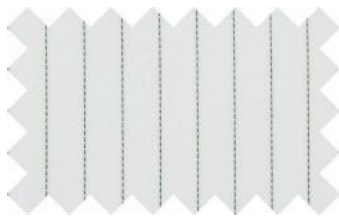
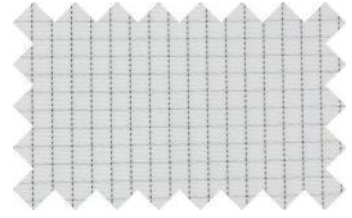
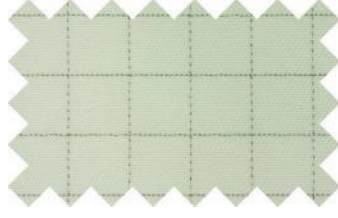
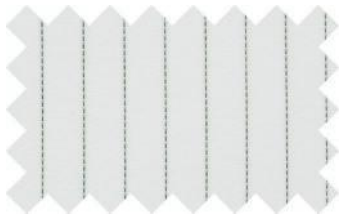
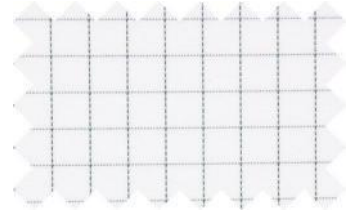
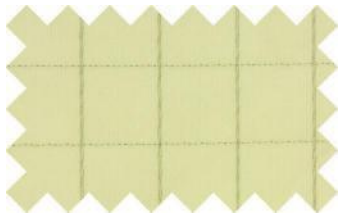

## • Fabric & Cleanroom Garment

### Introduction:

Cleanroom/ESD Garment is used in the place where proper protection against particle contamination and ElectroStatic Discharge is required.

We can supply you with this garment as well as the fabric.

We have various styles of garments such as Coverall, Gown, Lab Coat, T-shirt, etc. in our range

### Features:

- ① Produced on your required design and abric Produced by skilled workers with wide experience
- ② Produced with high quality fabric and sewing accessories
- ③ Considering air permeability, comfortability, wearability and durability Strict quality control from fabric to finished garment
- ④ Small quantity also can be supplied

## • Cleanroom&ESD Coverall/Jumpsuit- With cap or Without cap

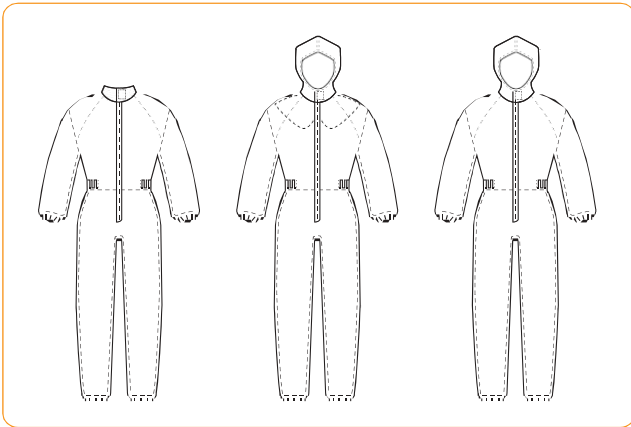

## • Cleanroom&ESD Smock(Zip or Button type)

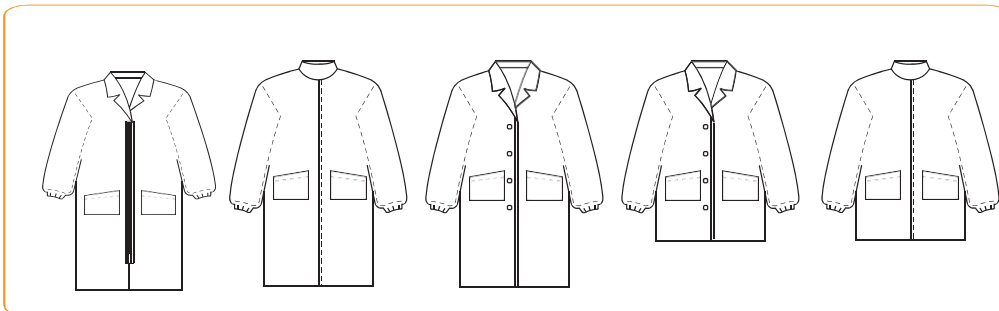

## • Cleanroom&ESD Jacket&Pant



## • Cleanroom&ESD T Shirt



## Cleanroom&ESD Garment -Some Type



HB-102 直拉不連帽連體服



### • Sewing Thread-Lint Free

Free of particle generation

Color: White, Sky Blue, Navy Blue and Olive Green

Standard Packing: 245 grams/cone, 10 cones/box, 10 boxes/carto



- Free of particle generation & ESD control  
S/R: 10e6 ohm
- Color: Grey  
Standard Packing: 245 grams/cone, 10 cones/box, 10 boxes/carto

# ESD Shoe Serials

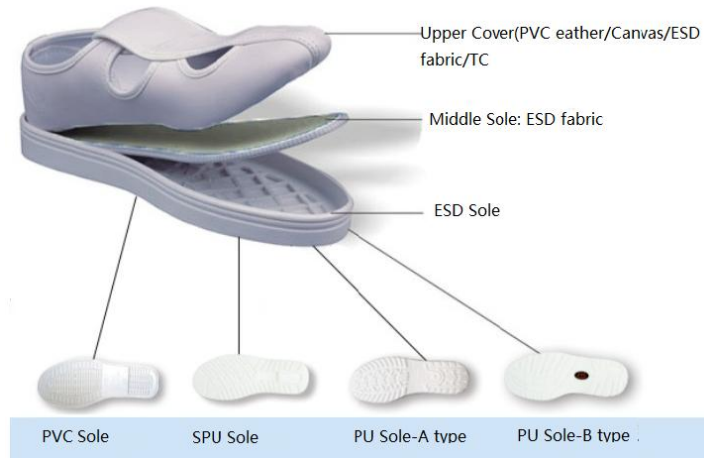

## ESD Slipper Serials



# ESD Shoe Serials

## ESD Long Booties Serials



## ESD Safety Shoes and Boots

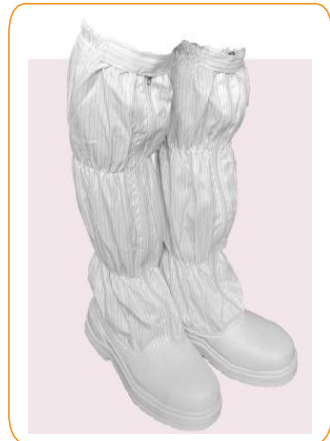

Size Check List															
<b>MP</b>	220	225	230	235	240	245	250	255	260	265	270	275	280	285	290
<b>EUR</b>	34	35	36	37	38	39	40	41	42	43	44	45	46	47	48

Material - PU outsole + PVC Leather,ESD Fabric, T/C in sole + Artificial leather cover + Steel toe cap  
 Advantage - RTG: 10e7-10e9 ohm, safety footwear, recyclable PU outsole, durable and long lasting, non-slip, oil resistant, abrasion resistant, shock absorption. low particles generation, cleanroom applicable .

# Disposable Gloves

## Cleanroom Gloves

### ● Latex Gloves- Powder free(9" & 12")



Part Name	Latex Gloves
Material	Natural High Grade Rubber Latex
Color	Natural
Length (All sizes)	9"(230mm) ± 10mm; 12"(300mm) ± 10mm
Palm width (S/M/L)	85/95/105 ± 3mm
Features	Powder free, Palm textured, Smooth texture Beaded cuff, Non-sterile, Double Chlorinated
Packing	100pcs/bag or Box, 10bags/carton

### ● Latex Gloves- Powder free(Long Cuff- 16")



Part Name	Latex Gloves
Material	Natural High Grade Rubber Latex
Color	Natural
Length (All sizes)	16"
Palm width (S/M/L)	85/95/105 ± 3mm
Features	Powder free, Palm textured, Smooth texture Beaded cuff, Non-sterile, Double Chlorinated
Packing	50pcs/bag 10bags/carton

### ● Nitrile Gloves- Powder free(9" & 12")



Part Name	Nitrile Gloves
Material	100% Synthetic Nitrile Latex
Class	Powder Free/Class1000/Class1000
Color	White/Blue/Orange/Black
Length (All sizes)	9"(230mm) ± 10mm; 12"(300mm) ± 10mm
Palm width (S/M/L)	85/95/105 ± 3mm
Features	Powder Free(2mg/glove), Finger Textured, Beaded cuff, Single Chlorinated
Packing	100pcs/bag 10bags/carton, 100pcs/box, 10boxes/carton

# Disposable Gloves

## ● Nitrile Gloves- Powder free (ESD Function)



Part Name	Nitrile Gloves
Material	100% Synthetic Nitrile Latex
SR	10e7-10e10
Class	Powder Free
Color	White/Blue/Orange/Black
Length (All sizes)	9"(230mm) ± 10mm; 12"(300mm) ± 10mm
Palm width (S/M/L)	85/95/105 ± 3mm
Features	Powder Free(2mg/glove), Finger Textured, Beaded cuff, Single Chlorinated
Packing	100pcs/bag 10bags/carton,

## ● Nitrile Gloves- Powder free (Long Cuff -16")



Part Name	Nitrile Gloves
Material	100% Synthetic Nitrile Latex
Class	Powder Free
Color	Blue
Length (All sizes)	16"
Palm width (S/M/L)	85/95/105 ± 3mm
Features	Powder Free(2mg/glove), Finger Textured, Beaded cuff, Single Chlorinated
Packing	50pcs/bag 10bags/carton,

## ● Vinyl Gloves-Powder free(9"&12")

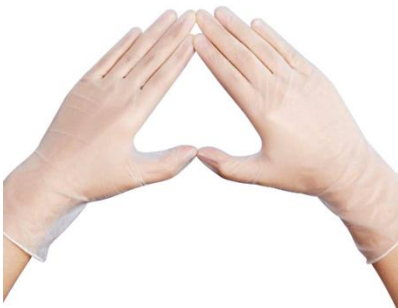

Part Name	Vinyl Gloves
Material	Polyvinyl Chloride
Class	Powder Free
Color	Clear
Length (All sizes)	9"&12"
Palm width (S/M/L)	85/95/105 ± 3mm
Features	Powder Free(2mg/glove), Finger Textured, Beaded cuff,
Packing	100pcs/bag or 100pcs/box 10bags or10box/carton

## ● Ultra Pure PE Gloves- For Polysilicon



Ultra Pure PE Gloves(UPPG), made of additive free pure polyethylene, are high pure and clean Gloves, which are suitable for a Polysilicon manufacturing process. Originally, UPPG have been developed to meet the high cleanliness level of polysilicon manufacturing industry. The main application of this glove is to handle pure chunk of polysilicon in the polysilicon manufacturing process or it can be used in the process of monocrystal ingot in wafer factories as well.

# Working Gloves

## Anti Static Gloves:



### Antistatic Polyester Gloves

- Material: polyester with ECF
- SR:  $10e7 \sim 10e9$  ohm



### Antistatic PVC Dot Gloves

- Material: polyester with ECF, PVC Dot on Palm
- SR:  $10e7 \sim 10e9$  ohm



### Antistatic Polyester Gloves

- Material: polyester with ECF
- SR:  $10e7 \sim 10e9$  ohm



### Antistatic PU Coating Gloves

- Material: polyester with ECF, PVC Dot on Palm  
PU laminated on TC fabric on Palm
- SR:  $10e7 \sim 10e9$  ohm



### Antistatic Microfiber Gloves

- Material: polyester with ECF Microfiber fabric
- SR:  $10e7 \sim 10e9$  ohm



### Microfiber Gloves

- Material: Microfiber fabric

## ●Static Control Gloves

### Features

- Made of static control carbon yarn mixed nylon(ESD) and copper yarn mixed nylon(Conductive)
- Excellent when tactile sensitivity is important in handling small parts
- Suitable for the places where cleanliness and ESD control is required
- Provides protection to operator's hands and products being handled
- Good elasticity, ventilation and minimizing sweat buildup
- Good grip
- Stable ESD properties

# Working Gloves



Conductive Elastic Fit Gloves



Conductive Top PU Gloves



Conductive Palm PU Gloves



ESD Elastic Fit Gloves



ESD Top PU Gloves



ESD Palm PU Gloves



ESD Top PU Gloves



ESD Light Grey Gloves



Antistatic Palm PU Gloves

## • Polyester Gloves

### Features

- Polyurethane coating provides super grip and abrasion resistance.
- Polyurethane coating eliminates fingers fatigue associated with finger cots and allows handling of very small parts without fingerprint contamination.
- Protects handling products from sweat and dust. Optimum comfortability and dexterity
- Low lint



Half Elastic Fit Gloves



ESD Light Grey Gloves



Antistatic Palm PU Gloves



Top Grey PU Gloves



Palm Grey PU Gloves



Black Palm NBR Foam Glove

# Cleanroom Clean products

## Sticky Mat

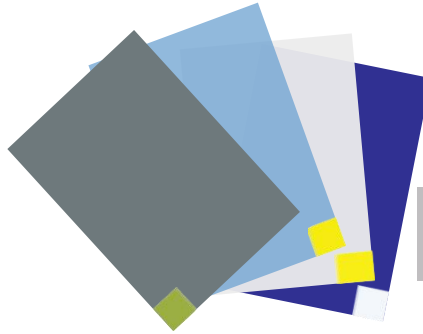
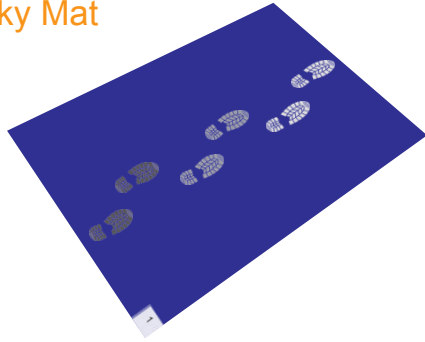

Size: 18" x 36", 18" x 45", 24" x 36", 26" x 45", etc.  
 Color: Blue, Grey, White, Light green, Clear  
 Packing: 30sheets, 8mats, 10mats/case, etc.

### Features

- 99.8% of dust collection at several steps on the mats.
- Collected dust on the mats is not migrated.
- Comfortable walking and smooth passing of hand carts.
- Mat can be used with/without the frame.
- Thin film sticky mat at economic price is another option.

### ●Frame For Sticky Mat



Drawing of the frame

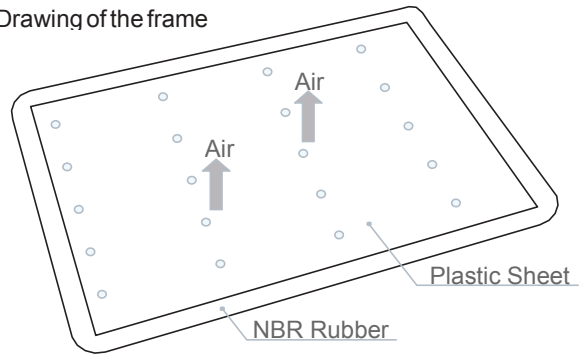

### ●PE Sticky Roller & Antistatic PE Sticky Roller



Color: Blue, White, Transparent  
 Size: 100, 150, 160, 200, 250, 300, 450, 500 mm, etc.  
 Length: 20m/roll  
 Core: 38mm, 76mm (3")

### ● Roller Handle



Material: Plastic Handle  
 Size: 4/6/8/10/12inch  
 Length: can be adjust to 1.5m

### ●Non-Woven Sticky Roller



Color: White  
 Size: 80, 160, 320 mm  
 Length: 10, 20m/roll  
 Core: 38mm, 76mm (3")

# Cleanroom Clean products

## ●PCB Cleaning Roll

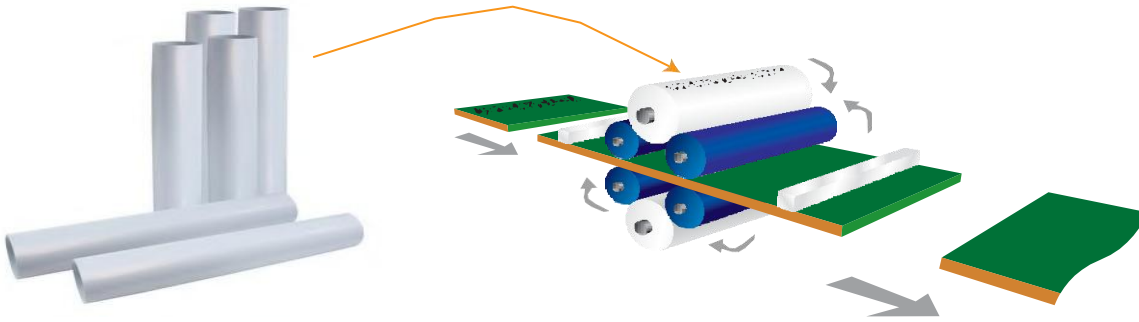

Normally, PCB Cleaning Roll goes with machine, not with a handle, and this roll is mainly designed for cleaning PCB. To clean the surface of PCB effectively, perfect flat conditions of the roll are essential. Several different adhesive levels are available for different applications.

## ●Silicone Rubber Roller



Material	Silicone Roller+Aluminum Handle
Standard Width	2" 3" 4" 6" 8" 10" 12" ~24" or customized
Roller Color	Blue
Handle	Black Plastic Handle
Tackiness	No Tackiness/Low/Middle/High/Super High Tackiness
Protective film	PET
Usage	Lint Removal
Applications	Applicable to breadboard, PCB, LCD, SMT, clean room, stainless steel sheet, film for dusting and etc.
Packing	1pcs/ESD shielding bag/box

## ●DCR-Pad



### Features

- Use with reusable Rubber Rollers.
- Excellent cleaning guaranteed.
- Cost-effective.
- Variations available;
  - DCR-Pad with full adhesive area (standard)
  - BCR-Pad with adhesive free area
  - Black colored DCR-Pad for better dust visibility

### Size

- 1) 330mm x 240mm (Adhesive area: 330 x 180mm)
- 2) 165mm x 240mm (Adhesive area: 165 x 180mm)

## ● Sticky Tack Cloth For Car Paint Cleaning

<b>Product Name</b>	Tack Cloth
<b>Material</b>	Cotton, Non-woven, Long Filament
<b>Color</b>	White, Yellow
<b>Packing</b>	1 Pcs Per Polybag, 10 Polybag Per Box, 20 Boxes Per Carton



### Features:

1. Helps ensure blemish-free finishing for all paintable surfaces
2. Light adhesive draws dust and other particles in and traps them in the cloth
3. Reduces adhesive transfer to the hands or gloves, helping ensure a clean work area
4. Leaves no drag marks on cleaned area
5. Silicone-free

# New Energy Serial - New Coming

## ● Package & Transportation



Ultra Clean PE bags

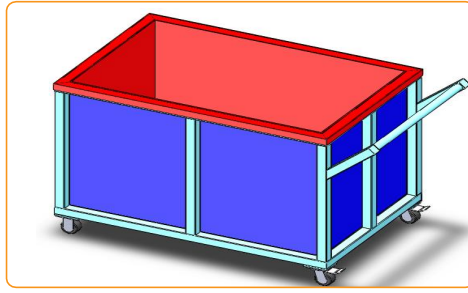

PU Turnarounds Trolley

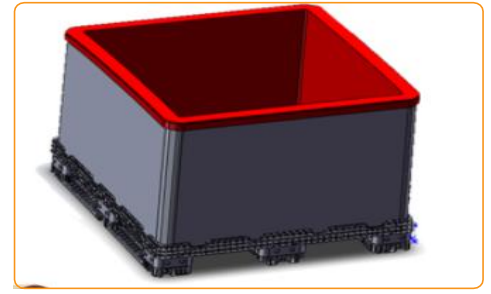

PU Crusher Boxes

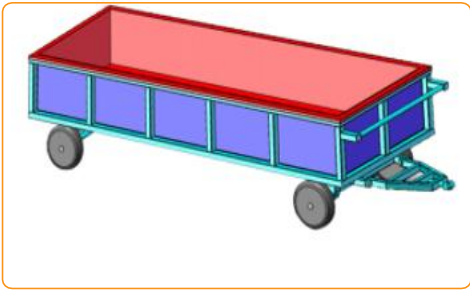

Silicon Rods Trolley



Silicon Transfer Box&Cardboard

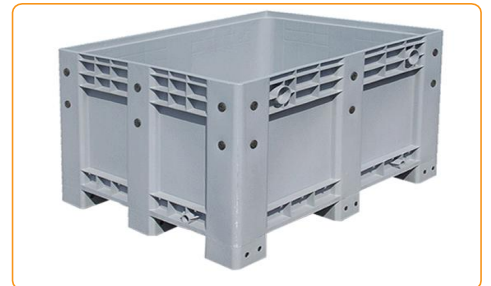

Silicon Transfer Box-PPT

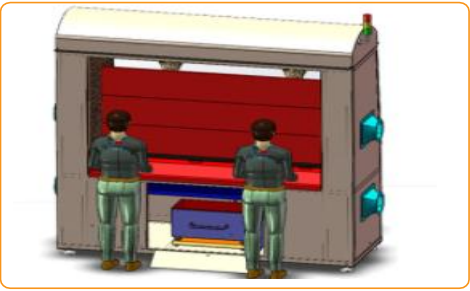

Silicon Crushers

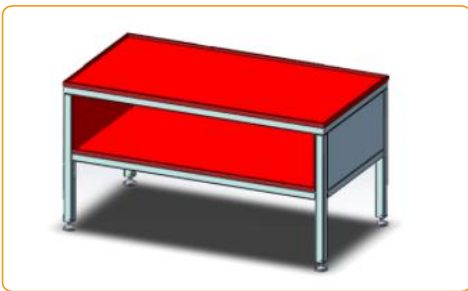

Silicon weighing table

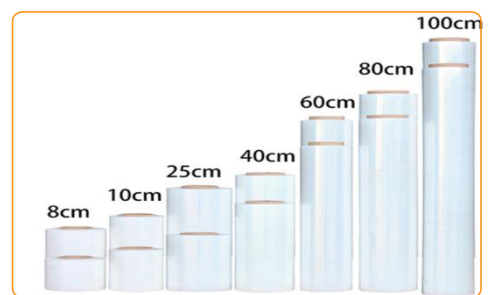

Wrap Packaging Film

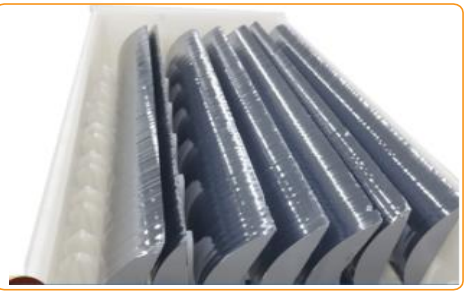

Partition Boxes



PE Square Bottom Bag



Machine Covering-ESD Fabric

## ● Materials & Tools

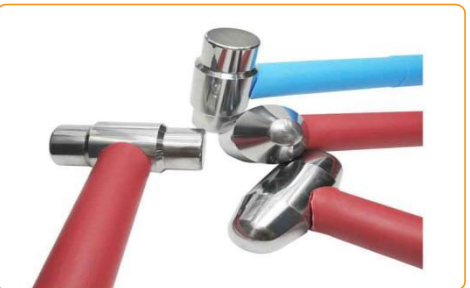

# New Energy Serial - New Coming

Breaking Hammers

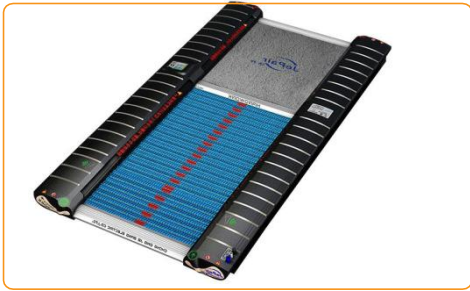

Silicon Spatula

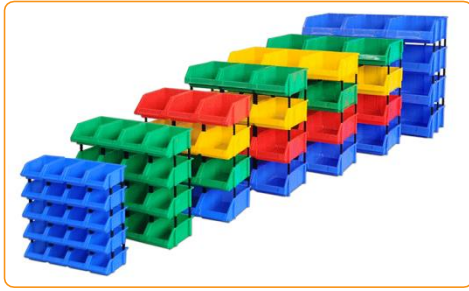

Wafer Circulate Box



Sole-Washing Machine



Parts Box



Silicon Barrel



Sandpaper

Carbon polyester fabric

Plastic Pallet

## ● Equipment

