



European Famous Brand



www.chinasy.net
www.chinasy.en.alibaba.com
www.globalsources.com/chinasy.co

ZHEJIANG SHUANGYANG GROUP CO.,LTD.

ADD: Wuli, Guanhaiwei Town, Cixi, Ningbo City, China.

TEL: +86-574-58582549

FAX: +86-574-63601456

ZHEJIANG SHUANGYANG GROUP CO.,LTD.

BRIEF

Zhejiang Shuangyang Group Co.,Ltd was established in 1986, and approved by ISO 9001/ ISO14000/ OHSAS18000. Acting as a private owned enterprise, one of Star Enterprise of Ningbo City, our total capital is 90 million U.S.Dollars with registered capital 16 million U.S. Dollars. Our construction area is about 100,000 sqm. In 2014, we have 680 employees with total turn over 70 million U.S.Dollars.

Our key products are timer sockets, flexible cord, rubber cable, cable reel, lighting and steel pipe. We registered the trade mark in Europe and U.S.A, and products certified by VDE/CE/GS/S/D/FI/N/CCC/RoHs/REACH and so on.

In 2010, we cooperated with VDE institute to apply product identification label on extension cord set. That service was the first time that VDE institute offer to manufacturer. And till 2015, we are the only manufacturer who uses PID service of VDE in the world. Also at the end of 2012, our test center qualified by VDE institute and can test the cable in our own lab.

Based on good quality, many importers and stores in Europe cooperate directly with us. Customers satisfaction always take priority during past years and president Mr. Luo Guo Ming is inspirational to build a hundred years enterprise. We warmly welcome customers all over the world to establish long term business relations!

President Luo Guo Ming



PRODUCTION LINES



High Quality control equipments
100% testing control
On time delivery

Production capacity monthly
Timer switch: 500,000pcs
Cable: 6000KM
Extension cord: 500,000pcs
Cable reel: 60,000pcs



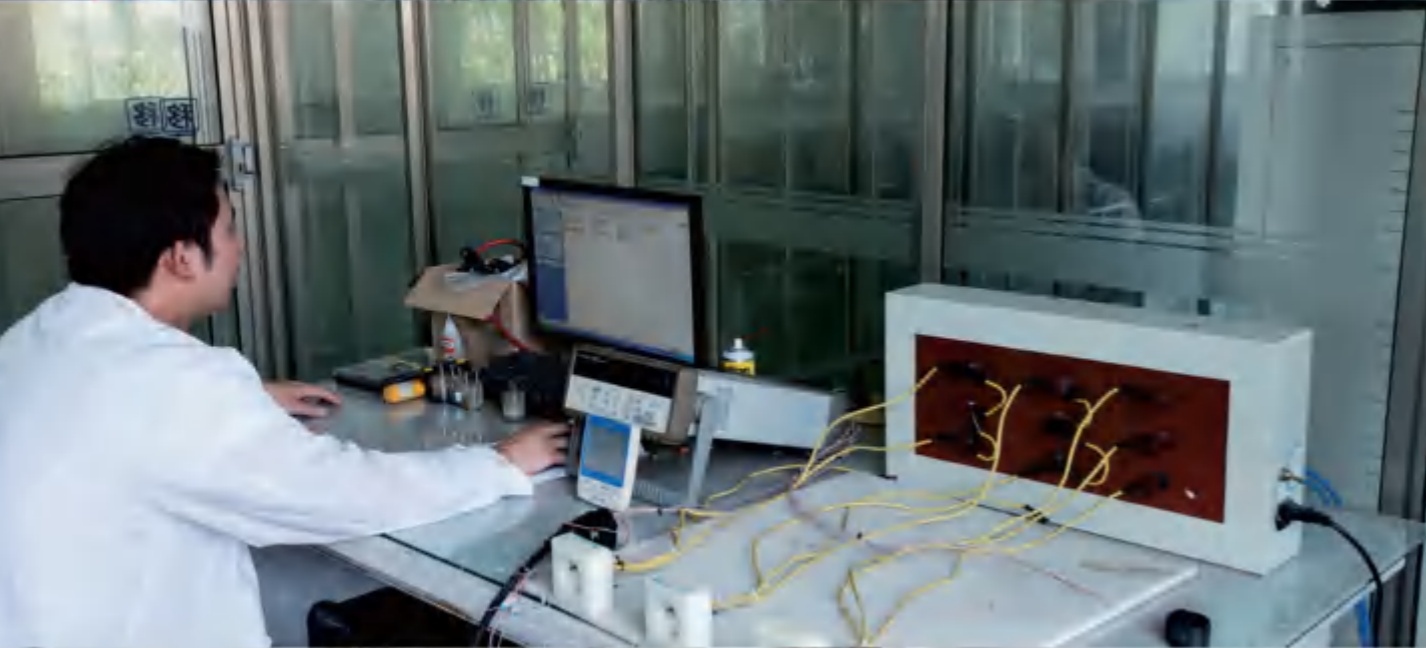
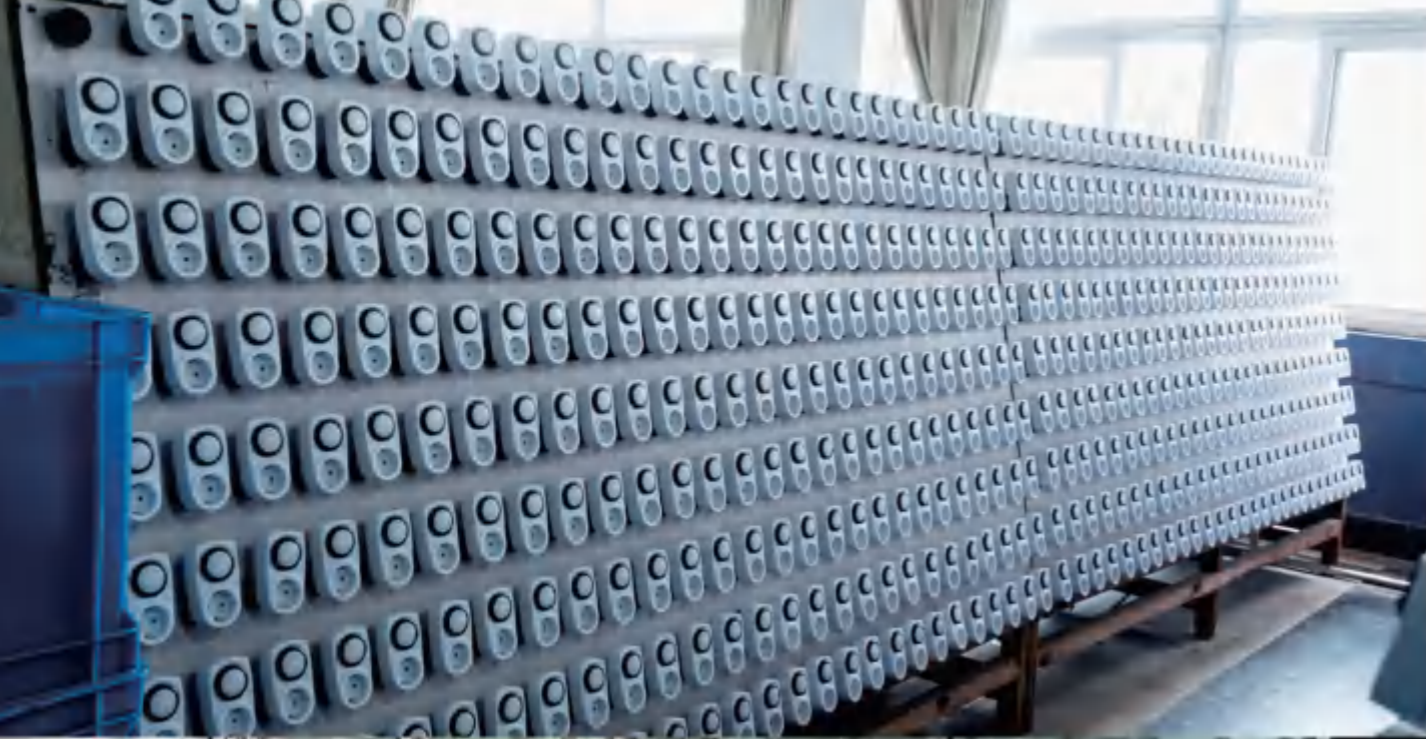

CONTENTS



Timer
01~12



USB Socket
13~14



Earth Leakage Circuit Breaker
15~17

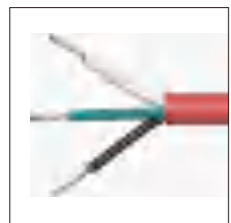

Cable & Wire
18~28



Power Cord
29~33



Assemble plug & Socket
34~39



Water-proof Box
40~41



Extension Cord
42~58

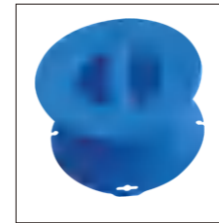

Cable Organizer
59~61



Cable Reel
62~81



Industrial Plug
82~99



Extension Sockets
100~106



Gardenspike Sockets
107~108



New Products
109~110



European Famous Brand

Timer



www.chinasy.net
www.chinasy.en.alibaba.com
www.globalsources.com/chinasy.co



>> **Timer**



TS-MD201 Mini 24 hours mechanical timer

- 24 On/Off
- 24 hours programming
- Minimum setting:30minutes
- Compact and elegant design for easy operation
- Power supply:220~240VAC/16A/50Hz max.3500W

Package	Q'ty/Box	Q'ty/Ctn	G. W	N. W	Ctn Size	Q'ty/20'FT
Double blister(a)	12PCS	48PCS	7.4KGS	5.4KGS	57×44×23CM	23040PCS

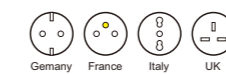

Intertek **CE RoHS REACH PAHS**



TS-MD202 Outdoor mini 24 hours mechanical timer

- 24 On/Off
- Water proof:IP44
- 24 hours programming
- Minimum setting:30minutes
- Compact and elegant design for easy operation
- Power supply:220~240VAC/16A/50Hz max.3500W

Package	Q'ty/Box	Q'ty/Ctn	G. W	N. W	Ctn Size	Q'ty/20'FT
Double blister(a)	12PCS	48PCS	12.5KGS	10.5KGS	61×52×25CM	16800PCS



Intertek **CE RoHS REACH PAHS**



TS-MD31 24 hours mechanical timer

- 48 On/Off
- 24 hours programming
- Minimum setting:15minutes
- Accuracy: Less than 6 minutes each day
- Compact and elegant design for easy operation
- Power supply:220~240VAC/16A/50Hz max.3500W

Package	Q'ty/Box	Q'ty/Ctn	G. W	N. W	Ctn Size	Q'ty/20'FT
Double blister(a)	12PCS	48PCS	13KGS	11KGS	61×48×25CM	18720PCS

Intertek **CE RoHS REACH PAHS**



>> Timer



>> Timer



TS-MD4 Outdoor 24 hours mechanical timer

- 48On/Off
- Water proof:IP44
- 24 hours programming
- Minimum setting:15minutes
- Accuracy: Less than 6 minutes each day
- Compact and elegant design for easy operation
- Power supply:220~240VAC/16A/50Hz max.3500W

Package	Q'ty/Box	Q'ty/Ctn	G.W	N.W	Ctn Size	Q'ty/20'FT
Double blister(a)	12PCS	48PCS	17KGS	13KGS	64×56×25CM	14976PCS



Intertek **CE RoHS REACH PAHS**



TS-MD20 24 hours mechanical timer

- 48 On/Off
- 24 hours programming
- Minimum setting:15minutes
- Accuracy: Less than 6 minutes each day
- Compact and elegant design for easy operation
- Power supply:220~240VAC/16A/50Hz max.3500W

Package	Q'ty/Box	Q'ty/Ctn	G.W	N.W	Ctn Size	Q'ty/20'FT
Double blister(a)	12PCS	48PCS	11KGS	9KGS	55.5×54.5×28CM	15840PCS

Intertek **CE KEMA RoHS REACH PAHS**



TS-MD4-D Outdoor 24 hours mechanical timer

- 48On/Off
- Water proof:IP44
- Special for Germany market
- 24 hours programming
- Minimum setting:15minutes
- Accuracy: Less than 6 minutes each day
- Compact and elegant design for easy operation
- Power supply:220~240VAC/16A/50Hz max.3500W

Package	Q'ty/Box	Q'ty/Ctn	G.W	N.W	Ctn Size	Q'ty/20'FT
Double blister(a)	12PCS	48PCS	17KGS	13KGS	64×56×25CM	14976PCS

Intertek **CE RoHS REACH PAHS**



TS-MD24 24 hours mechanical timer

- 48 On/Off
- 24 hours programming
- Minimum setting:15minutes
- Accuracy: Less than 6 minutes each day
- Compact and elegant design for easy operation
- Power supply:220~240VAC/16A/50Hz max.3500W

Package	Q'ty/Box	Q'ty/Ctn	G.W	N.W	Ctn Size	Q'ty/20'FT
Double blister(a)	12PCS	48PCS	15.5KGS	11.5KGS	68×52.5×28.5CM	23040PCS



Intertek **CE RoHS REACH PAHS**



TS-MD9 24 hours mechanical timer

- 48 On/Off
- 24 hours programming
- Minimum setting:15minutes
- Accuracy: Less than 6 minutes each day
- Compact and elegant design for easy operation
- Power supply:220~240VAC/16A/50Hz max.3500W

Package	Q'ty/Box	Q'ty/Ctn	G.W	N.W	Ctn Size	Q'ty/20'FT
Double blister(a)	12PCS	48PCS	13KGS	11KGS	61×48×25CM	18720PCS

Intertek **CE RoHS REACH PAHS**



TS-MD1 24 hours mechanical timer

- 48 On/Off
- 24 hours programming
- Minimum setting:15minutes
- Accuracy: Less than 6 minutes each day
- Compact and elegant design for easy operation
- Power supply:220~240VAC/16A/50Hz max.3500W

Package	Q'ty/Box	Q'ty/Ctn	G.W	N.W	Ctn Size	Q'ty/20'FT
Double blister(a)	12PCS	48PCS	13KGS	11KGS	61×48×25CM	18336PCS

Intertek **CE RoHS REACH PAHS**



>> Timer

>> Timer



TS-WD1 Weekly mechanical timer

- 42 On/Off
- 7 days programming
- Minimum setting: 2 hours
- Compact and elegant design for easy operation
- Power supply: 220~240VAC/16A/50Hz max. 3500W

Package	Q'ty/Box	Q'ty/Ctn	G.W	N.W	Ctn Size	Q'ty/20'FT
Double blister(a)	12PCS	48PCS	13KGS	11KGS	61×48×25CM	18720PCS



Intertek **CE RoHS REACH PAHS**



TS-ED1 Digital weekly timer

- Time display :hour/minute/second
- Accuracy: Less than 3 seconds in one day
- Rechargeable NI-MH battery used inside
- 8 buttons for easy operation
- Easy changeover for summer timer
- 12/24 hours change
- Power supply: 220~240VAC/16A/50Hz max. 3500W
- Reset function
- Random function
- 8 On/Off

Package	Q'ty/Box	Q'ty/Ctn	G.W	N.W	Ctn Size	Q'ty/20'FT
Double blister(a)	12PCS	48PCS	13KGS	11KGS	61.5×52.5×23CM	18000PCS



Intertek **CE RoHS REACH PAHS**



TS-ED201 Mini digital weekly timer

- 8 buttons for easy operation
- Easy changeover for summer timer
- Max time of counting down: 23h 59m 59s
- Time display :hour/minute/second
- Slim switch for easy setting
- Rechargeable NI-MH battery used inside
- Accuracy: Less than 3 seconds in one day
- Power supply: 220~240VAC/7.8A/50Hz max. 1780W
- 12/24 hours change
- Reset function
- Random function
- Countdown function
- 20 On/Off

Package	Q'ty/Box	Q'ty/Ctn	G.W	N.W	Ctn Size	Q'ty/20'FT
Double blister(a)	12PCS	48PCS	7.4KGS	5.4KGS	57×44×23CM	23040PCS



CE RoHS REACH PAHS



TS-ED4 Outdoor digital weekly timer

- 8 buttons for easy operation
- Easy changeover for summer timer
- Time display :hour/minute/second
- Accuracy: Less than 3 seconds in one day
- Rechargeable NI-MH battery used inside
- Random function
- Power supply: 220~240VAC/16A/50Hz max. 3500W
- Water proof: IP44
- Reset function
- 8 On/Off

Package	Q'ty/Box	Q'ty/Ctn	G.W	N.W	Ctn Size	Q'ty/20'FT
Double blister(a)	12PCS	48PCS	17KGS	13KGS	74×59×25.5CM	12108PCS



CE RoHS REACH PAHS



TS-ED202 Outdoor mini digital weekly timer

- 8 buttons for easy operation
- Easy changeover for summer time
- Slim switch for easy setting
- Time display :hour/minute/second
- Accuracy: Less than 3 seconds in one day
- Max time of counting down: 23h 59m 59s
- Rechargeable NI-MH battery used inside
- Power supply: 220~240VAC/7.8A/50Hz max. 1780W
- Water proof: IP44
- Reset function
- Random function
- 20 On/Off
- Countdown function

Package	Q'ty/Box	Q'ty/Ctn	G.W	N.W	Ctn Size	Q'ty/20'FT
Double blister(a)	12PCS	48PCS	12.5KGS	10.5KGS	61×52×25CM	16800PCS



Intertek **CE RoHS REACH PAHS**



TS-ED8 Digital weekly timer

- Time display :hour/minute/second
- Accuracy: Less than 3 seconds in one day
- Rechargeable NI-MH battery used inside
- 8 buttons for easy operation
- Easy changeover for summer timer
- 12/24 hours change
- Power supply: 220~240VAC/16A/50Hz max. 3500W
- Reset function
- Random function
- 8 On/Off

Package	Q'ty/Box	Q'ty/Ctn	G.W	N.W	Ctn Size	Q'ty/20'FT
Double blister(a)	12PCS	48PCS	13KGS	11KGS	61.5×52.5×23CM	18000PCS



Intertek **CE RoHS REACH PAHS**

>> Timer



>> Timer



TS-ED20 Digital weekly timer

- 7 buttons for easy operation
- Easy changeover for summer timer
- Time display :hour/minute/second
- Accuracy: Less than 3 seconds in one day
- Rechargeable NI-MH battery used inside
- 12/24 hours change
- Power supply:220~240VAC/16A/50Hz max.3500W
- Random function
- Reset function
- 8 On/Off

Package	Q'ty/Box	Q'ty/Ctn	G.W	N.W	Ctn Size	Q'ty/20'FT
Double blister(a)	12PCS	48PCS	10KGS	8KGS	55×53×28CM	16464PCS



CE RoHS REACH PAHS



TS-MD22 24 hours mechanical timer

- 48On/Off
- Special for Germany market
- Water proof:IP44
- 24 hours programming
- Minimum setting:15minutes
- Accuracy: Less than 6 minutes each day
- Compact and elegant design for easy operation
- Power supply:220~240VAC/16A/50Hz max.3500W

Package	Q'ty/Box	Q'ty/Ctn
Double blister(a)	12PCS	48PCS

CE RoHS REACH PAHS

TS-ED9 Digital weekly timer

- 3 buttons for easy operation
- Easy changeover for summer timer
- Max time of counting down :23h 59m 59s
- Accuracy: Less than 3 seconds in one day
- Rechargeable NI-MH battery used inside
- Year/month/date display(perpetual calendar)
- 8 On/Off
- Count down function
- 12/24 hours change
- Random function
- Reset function

Package	Q'ty/Box	Q'ty/Ctn	G.W	N.W	Ctn Size	Q'ty/20'FT
Double blister(a)	10PCS	50PCS	13KGS	11.5KGS	52×22×38CM	32150PCS



CE RoHS REACH PAHS



TS-JD Power calculator

- The unit price of power can be set
- Power supply:220~240VAC/50Hz max.3500W
- Completely reset or partially reset function fro choosing
- Max working time display:999 hours;
- Max.consumption of power display:9999KWH
- Real time display and 12/24 hours can be switchable, Display of working time, supply voltage, supply current , power ,consumption of power, total cost of power and unit price of power ,etc
- 5 buttons for easy operation
- Large LCD display

Package	Q'ty/Box	Q'ty/Ctn	G.W	N.W	Ctn Size	Q'ty/20'FT
Double blister(a)	10PCS	60PCS	16KGS	11KGS	41×39.5×41CM	25440PCS



Intertek CE RoHS REACH PAHS

TS-VP1 Voltage protector

- 3 big buttons for easy operation
- Large red LCD display
- Reset function
- Range of LVD setted:140-209VAC
- Range of LVD setted:230-269VAC
- Range of the time for checking defined:5-999s
- Power supply:220~240VAC/16A/50Hz max.3500W

Package	Q'ty/Box	Q'ty/Ctn	G.W	N.W	Ctn Size	Q'ty/20'FT
Double blister(a)	10PCS	50PCS	13KGS	11.5KGS	52×22×38CM	32150PCS



TS-MD21 Count down timer

- Specifications:0.5hour/1hour/2hour/3hour/6hour/12hour
- Compact and elegant design for easy operation
- Power supply:220~240VAC/50Hz max.3500W

Package	Q'ty/Box	Q'ty/Ctn	G.W	N.W	Ctn Size	Q'ty/20'FT
Double blister(a)	12PCS	48PCS	13KGS	11KGS	61×48×25CM	18720PCS



Intertek CE RoHS REACH PAHS



>> Timer



>> Timer



C.P.-D1 Creepage protector

- It can be used cyclically
- Action time: ≤30 mS
- Action current: ≤30 mA
- Power supply: 220~240VAC/50Hz max. 3500W
- It's a safety device of earth-fault protection for electric appliances
- In case of electric leakage, it can automatically cut off the power supply and keep the human body safety

Package	Q'ty/Box	Q'ty/Ctn	G.W	N.W	Ctn Size	Q'ty/20'FT
Double blister(a)	12PCS	48PCS	13KGS	11KGS	61.5×52.5×23CM	18144PCS



TS-GM1 Mechanical industry timer

- 48 On/Off
- 24 hours programming
- Power consumption: 0.5W
- Power reserve: 100hours
- Switching capacity: 16A/250VAC

Package	Q'ty/Box	Q'ty/Ctn	G.W	N.W	Ctn Size	Q'ty/20'FT
Double blister(a)	50PCS	100PCS	10.5KGS	9KGS	38×25×29.4CM	121700PCS



C.P.-D4 Creepage protector for outdoor

- It's a safety device of earth-fault protection for electric appliances
- Water proof: IP44
- It can be used cyclically
- Action time: ≤30 mS
- Action current: ≤30 mA
- Power supply: 220~240VAC/50Hz max. 3500W
- In case of electric leakage, it can automatically cut off the power supply and keep the human body safety

Package	Q'ty/Box	Q'ty/Ctn	G.W	N.W	Ctn Size	Q'ty/20'FT
Double blister(a)	12PCS	48PCS	13KGS	11KGS	61.5×52.5×25CM	16608PCS



TS-GE2 Digital industry timer

- Easy changeover for summer time
- 24 hours and 7 days programming
- 7 big buttons for easy operation
- Large LCD display
- Accuracy: Less than 3 seconds in one day
- Power supply: 220~240VAC/50Hz max. 3500W
- Rechargeable NI-MH battery used inside, It's a free of harmful battery
- Real time display
- Reset function
- 8 On/Off

Package	Q'ty/Box	Q'ty/Ctn	G.W	N.W	Ctn Size	Q'ty/20'FT
Double blister(a)	10PCS	100PCS	16KGS	14KGS	51×31×56CM	31600PCS



TS-ED201-16 Mini digital weekly timer

- 8 buttons for easy operation
- Easy changeover for summer timer
- Max time of counting down: 23h 59m 59s
- Time display :hour/minute/second
- Slim switch for easy setting
- Rechargeable NI-MH battery used inside
- Accuracy: Less than 3 seconds in one day
- Power supply: 220~240VAC/16A/50Hz max. 3500W
- 12/24 hours change
- Reset function
- Random function
- Countdown function
- 20 On/Off

Package	Q'ty/Box	Q'ty/Ctn	G.W	N.W	Ctn Size	Q'ty/20'FT
Double blister(a)	12PCS	48PCS	7.4KGS	5.4KGS	57×44×23CM	23040PCS



TS-ED11 Digital weekly timer

- Time display :hour/minute/second
- Accuracy: Less than 3 seconds in one day
- Rechargeable NI-MH battery used inside
- 8 buttons for easy operation
- Easy changeover for summer timer
- Countdown function
- Power supply: 220~240VAC/16A/50Hz max. 3500W
- 12/24 hours change
- Reset function
- Random function
- 20 On/Off

Package	Q'ty/Box	Q'ty/Ctn	G.W	N.W	Ctn Size	Q'ty/20'FT
Double blister(a)	12PCS	48PCS	13KGS	11KGS	61.5×52.5×23CM	18000PCS



>> Timer



>> Timer



TS-ED12 Digital weekly timer

- Time display:hour/minute/second
- Accuracy:less than 3 seconds in one day
- Rechargeable NI-MH battery used inside
- 8 buttons for easy operation
- Easy changeover for summer timer
- Power supply:230VAC/16A/50Hz Max.3680W
- Random function
- Reset function
- 20 ON/OFF

Package	Q'ty/Box	Q'ty/Ctn	G.W	N.W	Ctn Size	Q'ty/20'FT
Double blister(a)	12PCS	48PCS	13KG	11KG	61.5×52.5×23CM	18000PCS



TS-MD203 Outdoor 24 hours mechanical timer

- 24On/Off
- Water proof:IP44
- 24 hours programming
- Minimum setting:30minutes
- Compact and elegant design for easy operation
- Power supply:230VAC/16A/50Hz Max.3680W

Package	Q'ty/Box	Q'ty/Ctn	G.W	N.W	Ctn Size	Q'ty/20'FT
Double blister(a)	12PCS	48PCS	11.5KGS	8.5KGS	62×56×23CM	16800PCS



TS-ED203 Outdoor digital weekly timer

- Time display:hour/minute/second
- Accuracy:less than 3 seconds in one day
- Rechargeable NI-MH battery used inside
- 4 buttons for easy operation
- Easy changeover for summer timer
- Power supply:230VAC/16A/50Hz Max.3680W
- Random function
- Reset function
- 20 ON/OFF
- Water proof:IP44

Package	Q'ty/Box	Q'ty/Ctn	G.W	N.W	Ctn Size	Q'ty/20'FT
Double blister(a)	12PCS	48PCS	13.4KG	10.4KG	65.5×62×23CM	14400PCS



TS-ME4 Outdoor 24 hours mechanical timer

- 48On/Off
- Water proof:IP44
- 24 hours programming
- Minimum setting:15minutes
- Accuracy: Less than 6 minutes each day
- Compact and elegant design for easy operation
- Power supply:230VAC/13A/50Hz max.2990W

Package	Q'ty/Box	Q'ty/Ctn	G.W	N.W	Ctn Size	Q'ty/20'FT
Double blister(a)	12PCS	48PCS	17KGS	13KGS	64×56×25CM	14976PCS



TS-ED204 Outdoor digital weekly timer

- Time display:hour/minute/second
- Accuracy:less than 3 seconds in one day
- Rechargeable NI-MH battery used inside
- 8 buttons for easy operation
- Easy changeover for summer timer
- Power supply:230VAC/16A/50Hz Max.3680W
- Random function
- Reset function
- 20 ON/OFF
- Water proof:IP44

Package	Q'ty/Box	Q'ty/Ctn	G.W	N.W	Ctn Size	Q'ty/20'FT
Double blister(a)	12PCS	48PCS	13.4KGS	10.4KGS	65.5×62×23CM	14400PCS



TS-ED15 WiFi Timer Socket

- Length x Wide x Depth: 96x50x68 MM
- Voltage: AC 230V, 50/60Hz
- Max current: 16A(Resistive current)
- Max Watts: 3680W(Resistive Load)
- The standard of WIFI: 802. 11b/g/n





European Famous Brand

USB Socket



USB-E3
USB O/P:DC 5V,Max 3.4A



www.chinasy.net
www.chinasy.en.alibaba.com
www.globalsources.com/chinasy.co



>> USB SOCKET



USB-D1

USB O/P:DC 5V,Max 2.1A

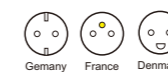
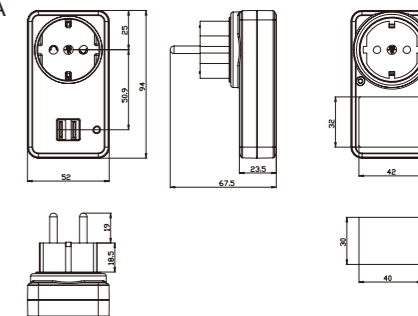

USB-D2

USB O/P:DC 5V,Max 2.1A

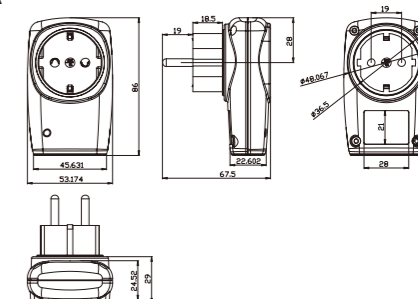

USB-NN3

USB O/P:DC 5V,Max 3.4A

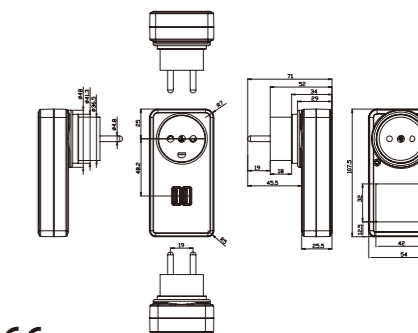



European Famous Brand

Earth Leakage Circuit Breaker



www.chinasy.net
www.chinasy.en.alibaba.com
www.globalsources.com/chinasy.co



>> Earth Leakage Circuit Breaker



CP-E3

- It's a safety device of earth-fault protection for electric appliance
- It can be used cyclically
- Residual Current: 30mA
- Tripping Time :<30ms
- Power supply:230VAC /50Hz /13A/ Max.3120W



CP-D3

- It's a safety device of earth-fault protection for electric appliance
- It can be used cyclically
- Residual Current: 30mA
- Tripping Time :<30ms
- Power supply:230VAC /50Hz /16A/ Max.3680W



CP-F3

- It's a safety device of earth-fault protection for electric appliance
- It can be used cyclically
- Residual Current: 30mA
- Tripping Time :<30ms
- Power supply:230VAC /50Hz /16A/ Max.3680W





>> Earth Leakage Circuit Breaker



CP-D4

- It's a safety device of earth-fault protection for electric appliance
- Water proof:IP44
- It can be used cyclically
- Residual Current: 30mA
- Tripping Time :<30ms
- Power supply:230VAC /50Hz /16A/ Max.3680W



CP-D5

- It's a safety device of earth-fault protection for electric appliance
- Water proof:IP44
- It can be used cyclically
- Residual Current: 30mA
- Tripping Time :<30mS
- Power supply:230VAC /50Hz /16A/ Max.3680W



CP-E5

- It's a safety device of earth-fault protection for electric appliance
- Water proof:IP44
- It can be used cyclically
- Residual Current: 30mA
- Tripping Time :<30mS
- Power supply:230VAC /50Hz /13A/ Max.3120W



European Famous Brand

Cable & Wire





H07BQ-F



Standard:E 8242:2014
Rated Voltage:450/750V
Max Temp:70°C

AT-N07V3V3-F



Standard:E 8242:2014
Rated Voltage:450/750V
Max Temp:70°C

Number and nominal cross-sectional area of conductors	Thickness of insulation Specified value	Thickness of sheath Specified value	Mean overall diameter	
			Lower limit	Upper limit
mm ²	mm	mm	mm	mm
2x1	0.8	0.9	6.9	9.0
2x1.5	0.8	1.0	7.6	9.8
2x2.5	0.9	1.1	9.0	11.6
2x4	1.0	1.2	10.6	13.7
2x6	1.0	1.3	11.8	15.1
2x10	1.2	2.0	15.6	19.9
2x16	1.2	2.1	17.9	22.8
3x1	0.8	0.9	7.3	9.5
3x1.5	0.8	1.0	8.0	10.4
3x2.5	0.9	1.1	9.6	12.4
3x4	1.0	1.2	11.3	14.5
3x6	1.0	1.4	12.8	16.3
3x10	1.2	2.1	16.8	21.4
3x16	1.2	2.3	19.5	24.7
4x1	0.8	1.0	8.2	10.7
4x1.5	0.8	1.1	9.0	11.6
4x2.5	0.9	1.2	10.7	13.8
4x4	1.0	1.3	12.7	16.2
4x6	1.0	1.5	14.2	18.1
4x10	1.2	2.2	18.6	23.6
4x16	1.2	2.3	21.3	27.0
5x1	0.8	1.1	9.2	11.9
5x1.5	0.8	1.1	9.8	12.7
5x2.5	0.9	1.3	11.9	15.3
5x4	1.0	1.4	14.1	17.9
5x6	1.0	1.6	15.7	20.0
5x10	1.2	2.3	20.4	25.9
5x16	1.2	2.5	23.7	30.0

Number of cores and cross section of conductors	Wall thickness of the insulating sheath		Wall thickness of the jacket						Average outside diameter		Insulation resistance at maximum operating temperature on the conductor(70°C)
			Single layer		Double layer						
					Inner casing		Outer casing				
mm ²	Nominal value	Minimum value	Nominal value	Minimum value	Nominal value	Minimum value	Nominal value	Minimum value	Minimum value	Maximum value	Minimum value
3x1	0.8	0.62	1.4	1.09	-	-	-	-	8.3	10.7	0.0120
3x1.5	0.8	0.62	1.6	1.26	-	-	-	-	9.2	11.9	0.0110
3x2.5	0.9	0.71	1.8	1.43	-	-	-	-	10.9	14.0	0.0104
3x4	1.0	0.80	1.9	1.52	-	-	-	-	12.7	16.2	0.0093
3x6	1.0	0.80	2.1	1.69	-	-	-	-	14.1	18.0	0.0072
3x10	1.2	0.98	3.3	2.71	1.3	1.01	2.0	1.60	19.1	24.2	0.0065
3x16	1.2	0.98	3.5	2.88	1.4	1.09	2.1	1.69	21.8	27.6	0.0054
4x1	0.8	0.62	1.5	1.18	-	-	-	-	9.2	11.9	0.0120
4x1.5	0.8	0.62	1.7	1.35	-	-	-	-	10.2	13.1	0.0110
4x2.5	0.9	0.71	1.9	1.52	-	-	-	-	12.1	15.5	0.0104
4x4	1.0	0.80	2.0	1.60	-	-	-	-	14.0	17.9	0.0093
4x6	1.0	0.80	2.3	1.86	-	-	-	-	15.7	20.0	0.0072
4x10	1.2	0.98	3.4	2.79	1.4	1.09	2.0	1.60	20.9	26.5	0.0065
4x16	1.2	0.98	3.6	2.96	1.4	1.09	2.2	1.77	23.8	30.1	0.0054
5x1	0.8	0.62	1.6	1.26	-	-	-	-	10.2	13.1	0.0120
5x1.5	0.8	0.62	1.8	1.43	-	-	-	-	11.2	14.4	0.0110
5x2.5	0.9	0.71	2.0	1.60	-	-	-	-	13.3	17.0	0.0104
5x4	1.0	0.80	2.2	1.77	-	-	-	-	15.6	19.9	0.0093
5x6	1.0	0.80	2.5	2.03	1.0	0.75	1.5	1.18	17.5	22.2	0.0072
5x10	1.2	0.98	3.6	2.96	1.4	1.09	2.2	1.77	22.9	29.1	0.0065
5x16	1.2	0.98	3.9	3.22	1.5	1.18	2.4	1.94	26.4	33.3	0.0054

FOR USE IN HEAVY-DUTY FACILITIES AND NORMAL ELECTRIC TOOLS · 适用于强电设备及一般电动工具



AT-N05V3V3-F



Number of cores and crosssection of conductors	Wall thickness of the insulating sheath		Wall thickness of the jacket		Average outside diameter		Insulation resistance at maximum operating temperature on the conductor(70°C)
	Nominal value	Minimum value	Nominal value	Minimum value	Minimum value	Maximum value	
mm ²	mm	mm	mm	mm	mm	mm	MΩ · km
3x0.75	0.6	0.44	0.8	0.58	6.4	8.0	0.011
3x1	0.6	0.44	0.8	0.58	6.8	8.4	0.010
3x1.5	0.7	0.50	0.9	0.67	8.0	9.8	0.010
3x2.5	0.8	0.62	1.1	0.84	9.6	12.0	0.009
3x4	0.8	0.62	1.2	0.92	11.0	13.0	0.007
4x0.75	0.6	0.44	0.8	0.58	6.8	8.6	0.011
4x1	0.6	0.44	0.9	0.67	7.6	9.4	0.010
4x1.5	0.7	0.50	1.0	0.75	9.0	11.0	0.010
4x2.5	0.8	0.62	1.1	0.84	10.5	13.0	0.009
4x4	0.8	0.62	1.2	0.92	12.0	14.0	0.007
5x0.75	0.6	0.44	0.9	0.67	7.4	9.6	0.011
5x1	0.6	0.44	0.9	0.67	8.3	10.0	0.010
5x1.5	0.7	0.50	1.1	0.84	10.0	12.0	0.010
5x2.5	0.8	0.62	1.2	0.92	11.5	14.0	0.009
5x4	0.8	0.62	1.4	1.09	13.5	15.5	0.007

FOR USE IN HEAVY-DUTY FACILITIES AND NORMAL ELECTRIC TOOLS · 适用于强电设备及一般电动工具

H05RR-F Vde Rubber Cable

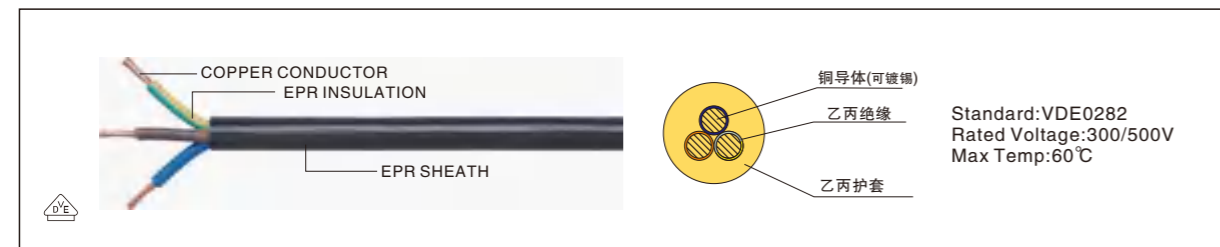

Area(mm ²) 截面积	Conductor 导体		Insulation 绝缘体 Nom.thick(mm) 厚度	Sheath 护套 Nom.thick(mm) 厚度	Meanoverall 平均外径	
	Construction(NO./mm) 结构	Diam.Of Single(mm)Max. 单支直径			Lower limit mm 下限	Upper limit mm 上限
2X0.75	24/0.2	0.21	0.6	0.8	5.7	7.4
2X1	32/0.2	0.21	0.6	0.9	6.1	8.0
2X1.5	48/0.2	0.26	0.8	1.0	7.6	9.8
2X2.5	49/0.25	0.26	0.9	1.1	9.0	11.6
3X0.75	24/0.2	0.21	0.6	0.9	6.2	8.1
3X1	32/0.2	0.21	0.6	0.9	6.5	8.5
3X1.5	48/0.2	0.26	0.8	1.0	8.0	10.4
3X2.5	49/0.25	0.26	0.9	1.1	9.6	12.4

FOR USE IN HEAVY-DUTY FACILITIES AND NORMAL ELECTRIC TOOLS · 适用于强电设备及一般电动工具

H05RN-F Vde Rubber Cable

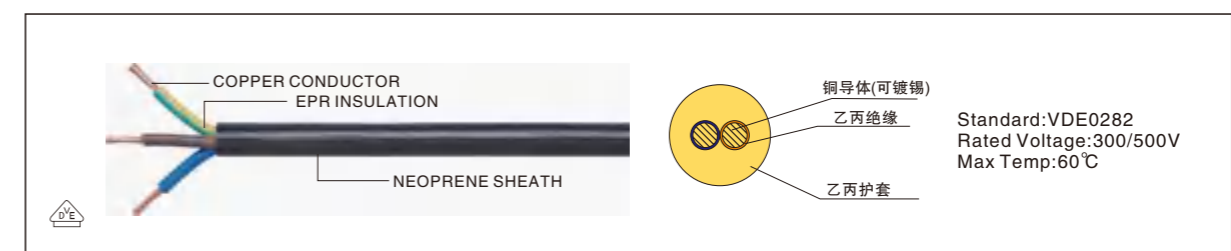

Area(mm ²) 截面积	Conductor 导体		Insulation 绝缘体 Nom.thick(mm) 厚度	Sheath 护套 Nom.thick(mm) 厚度	Meanoverall 平均外径	
	Construction(NO./mm) 结构	Diam.Of Single(mm)Max. 单支直径			Lower limit mm 下限	Upper limit mm 上限
2X0.75	24/0.2	0.21	0.6	0.8	5.7	7.4
2X1	32/0.2	0.21	0.6	0.9	6.1	8.0
3X0.75	24/0.2	0.21	0.6	0.9	6.2	8.1
3X1	32/0.2	0.21	0.6	0.9	6.5	8.5

FOR USE IN HEAVY-DUTY FACILITIES AND NORMAL ELECTRIC TOOLS · 适用于强电设备及一般电动工具

H07RN-F Vde Rubber Cable

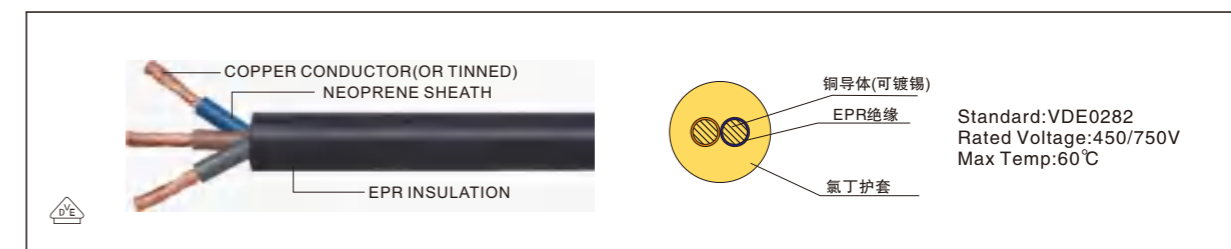

Area(mm ²) 截面积	Conductor 导体		Insulation 绝缘体 Nom.thick(mm) 厚度	Sheath 护套 Nom.thick(mm) 厚度	Meanoverall 平均外径	
	Construction(NO./mm) 结构	Diam.Of Single(mm)Max. 单支直径			Lower limit mm 下限	Upper limit mm 上限
2X1	32/0.2	0.21	0.8	1.3	7.7	10.0
2X1.5	48/0.25	0.26	0.8	1.5	8.5	11.0
2X2.5	49/0.25	0.26	0.9	1.7	10.2	13.1
3X1	32/0.2	0.21	0.8	1.4	8.3	10.7
3X1.5	48/0.2	0.26	0.8	1.6	9.2	11.9
3X2.5	49/0.25	0.26	0.9	1.8	10.9	14.0
3X4	81/0.25	0.26	1	1.9	12.7	16.2
3X6	123/0.25	0.26	1	2.1	14.1	18
4X1	32/0.2	0.21	0.8	1.5	9.2	11.9
4X1.5	48/0.2	0.21	0.8	1.7	10.2	13.1
4X2.5	49/0.25	0.26	0.9	1.9	12.1	15.5
4X4	81/0.25	0.26	1	2	14	17.9
4X6	123/0.25	0.26	1	2.3	15.7	20
5X1.5	48/0.2	0.21	0.8	1.8	11.2	14.4
5X2.5	49/0.25	0.26	0.9	2	13.3	17
5X4	81/0.25	0.26	1	2.2	15.6	19.9
5X6	123/0.25	0.26	1	2.5	17.5	22.2

FOR USE IN HEAVY-DUTY FACILITIES AND NORMAL ELECTRIC TOOLS · 适用于强电设备及一般电动工具



H01N2-D、H01N2-E Welder Cable

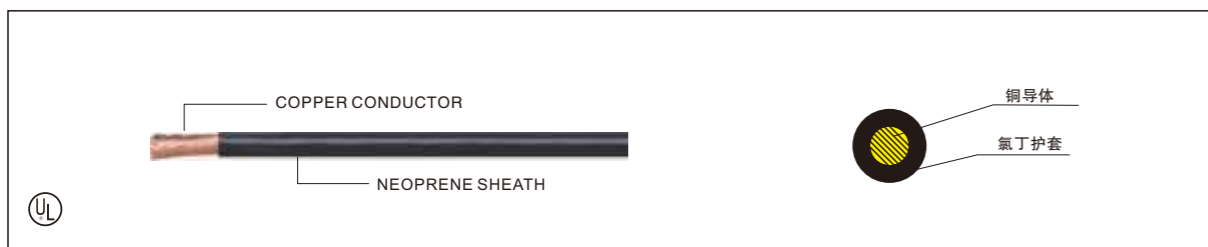

Area(mm ²) 导体标称面积	Diam.Of single (mm)Max 导体中单线最大直径	Sheath Thick(mm) 护套壁厚规定值	Mean overall 平均外径		Max insulation Resistance at 20°C	
			Lower limit(mm) 最小值	Upper limit(mm) 最大值	Tinned(/km) 镀锡导体	Not tinned(/km) 未镀锡导体
10	0.21	2.0	7.7	9.7	1.95	1.91
16	0.21	2.0	8.8	11.0	1.24	1.21
25	0.21	2.0	10.1	12.7	0.795	0.780
35	0.21	2.0	11.4	14.2	0.565	0.554
50	0.21	2.2	13.2	16.5	0.393	0.386
70	0.21	2.4	15.3	19.2	0.277	0.272
95	0.21	2.6	17.1	21.4	0.210	0.206
120	0.51	2.8	19.2	24.0	0.164	0.161
150	0.51	3.0	21.1	26.4	0.132	0.129
185	0.51	3.2	23.1	28.9	0.108	0.106

导体电阻按HD 383 6类导体

Area(mm ²) 导体标称面积	Diam.Of single (mm)Max 导体中单线最大直径	Sheath Thick(mm) 护套壁厚规定值	Mean overall 平均外径		Max insulation Resistance at 20°C	
			Lower limit(mm) 最小值	Upper limit(mm) 最大值	Tinned(/km) 镀锡导体	Not tinned(/km) 未镀锡导体
10	0.16	1.2	6.2	7.8	1.95	1.91
16	0.16	1.2	7.3	9.1	1.24	1.21
25	0.16	1.2	8.6	10.8	0.795	0.780
35	0.16	1.2	9.8	12.3	0.565	0.554
50	0.16	1.5	11.9	14.8	0.393	0.386
70	0.16	1.5	13.6	17.0	0.277	0.272
95	0.16	1.8	15.6	19.5	0.210	0.206
120	0.21	1.8	17.2	21.6	0.164	0.161
150	0.21	1.8	18.8	23.5	0.132	0.129
185	0.21	1.8	20.4	25.5	0.108	0.106

导体电阻按HD 383 6类导体

H03V V-F Vde Pvc Cable

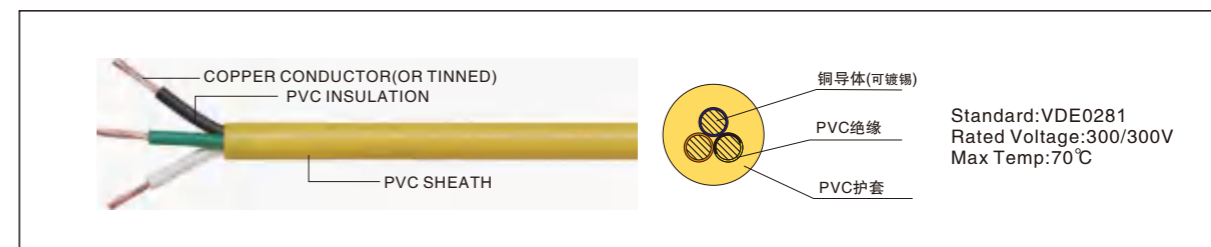

Area(mm ²) 截面积	Conductor 导体		Insulation 绝缘体	Sheath 护套	Meanoverall 平均外径		Minimum insulationl resistance at70°C 70°C时最小绝缘电阻MΩ·km
	Construction (NO./mm) 结构	Diam.Of Single (mm)Max. 单支直径	Nom.thick(mm) 厚度	Nom.thick(mm) 厚度	Lower limit mm 下限	Upper limit mm 上限	
2X0.5	16/0.2	0.21	0.5	0.6	4.6	5.9	0.012
2X0.75	24/0.2	0.21	0.5	0.6	4.9	6.3	0.010
3X0.5	16/0.2	0.21	0.5	0.6	4.9	6.3	0.012
3X0.75	24/0.2	0.21	0.5	0.6	5.2	6.7	0.010
4X0.5	16/0.3	0.21	0.5	0.6	5.4	6.9	0.012
4X0.75	24/0.2	0.21	0.5	0.6	5.7	7.3	0.010

INDOOR POWER SUPPLY OF ELECTRIC APPLIANCES · 适用于小型室内器具、家电产品电力供应线

H03V VH2-F Vde Pvc Cable

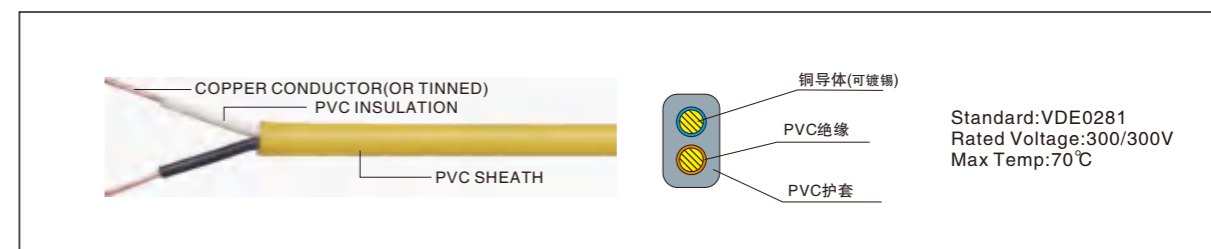

Area(mm ²) 截面积	Conductor导体		Insulation 绝缘体	Sheath 护套	Meanoverall平均外径		Minimum insulationl resistance at70°C 70°C时最小绝缘电阻MΩ·km
	Construction (NO./mm) 结构	Diam.Of Single (mm)Max. 单支直径	Nom.thick(mm) 厚度	Nom.thick(mm) 厚度	Lower limit mm 下限	Upper limit mm 上限	
2X0.5	16/0.2	0.21	0.5	0.6	3.0×4.9	3.7×5.9	0.012
2X0.75	24/0.2	0.21	0.5	0.6	3.2×5.2	3.8×6.3	0.010

INDOOR POWER SUPPLY OF ELECTRIC APPLIANCES · 适用于小型室内器具、家电产品电力供应线



>> Cable & Wire

>> Cable & Wire

H05V V-F Vde Pvc Cable

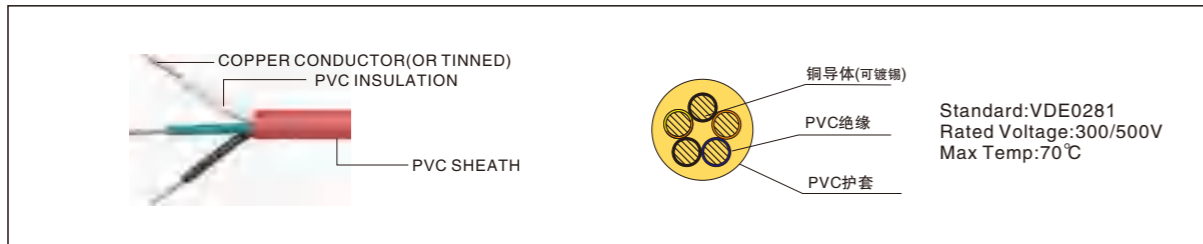

Area(mm ²) 截面积	Conductor 导体		Insulation 绝缘体 Nom.thick(mm) 厚度	Sheath 护套 Nom.thick(mm) 厚度	Mean overall 平均外径		Minimum insulation resistance at 70°C 70°C时最小绝缘电阻 MΩ·km
	Construction (NO./mm) 结构	Diam.Of Single (mm) Max. 单支直径			Lower limit mm 下限	Upper limit mm 上限	
2X0.75	24/0.2	0.21	0.6	0.8	5.7	7.2	0.011
2X1.0	32/0.2	0.21	0.6	0.8	5.9	7.5	0.010
2X1.5	48/0.2	0.26	0.7	0.8	6.8	8.6	0.001
2X2.5	49/0.25	0.26	0.8	1.0	8.4	10.6	0.009
2X4	56/0.3	0.31	0.8	1.1	9.7	12.1	0.007
3X0.75	24/0.2	0.21	0.6	0.8	6.0	7.6	0.011
3X1	32/0.2	0.21	0.6	0.8	6.3	8.0	0.010
*3X1.25	40/0.2	0.21	0.7	0.9	7.6	9.4	0.010
3X1.5	48/0.2	0.26	0.7	0.9	7.4	9.4	0.010
3X2.5	49/0.25	0.26	0.8	1.1	9.2	11.4	0.010
3X4	56/0.3	0.31	0.8	1.2	10.5	13.1	0.009
4X0.75	24/0.2	0.21	0.6	0.8	6.6	8.3	0.011
4X1	32/0.2	0.21	0.6	0.9	7.1	9.0	0.010
4X1.5	48/0.2	0.26	0.7	1.0	8.4	10.5	0.010
4X2.5	49/0.25	0.26	0.8	1.1	10.1	12.5	0.009
4X4	56/0.3	0.31	0.8	1.2	11.5	14.3	0.007
5X0.75	24/0.2	0.21	0.6	0.9	7.4	9.3	0.011
5X1	32/0.2	0.21	0.6	0.9	7.8	9.8	0.010
5X1.5	48/0.2	0.26	0.7	1.1	9.3	11.6	0.010
5X2.5	49/0.25	0.26	0.8	1.2	11.2	13.9	0.009
5X4	56/0.3	0.31	0.8	1.4	13.0	16.1	0.007

INDOOR POWER SUPPLY OF ELECTRIC APPLIANCES·适用于小型室内器具、家电产品电力供应线

H05V VH2-F Vde Pvc Cable

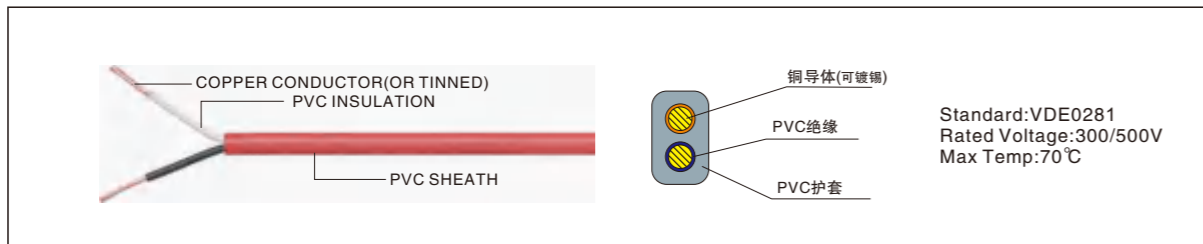

Area(mm ²) 截面积	Conductor 导体		Insulation 绝缘体 Nom.thick(mm) 厚度	Sheath 护套 Nom.thick(mm) 厚度	Mean overall 平均外径		Minimum insulation resistance at 70°C 70°C时最小绝缘电阻 MΩ·km
	Construction (NO./mm) 结构	Diam.Of Single (mm) Max. 单支直径			Lower limit mm 下限	Upper limit mm 上限	
2X0.75	24/0.2	0.21	0.6	0.8	3.7×6.0	4.5×7.2	0.011
2X1.0	32/0.2	0.21	0.6	0.8	3.9×6.2	4.5×7.5	0.01

INDOOR POWER SUPPLY OF ELECTRIC APPLIANCES·适用于小型室内器具、家电产品电力供应线

SPT-1、SPT-2、SPT-3F UI Flexible Cord And Fixture Wire

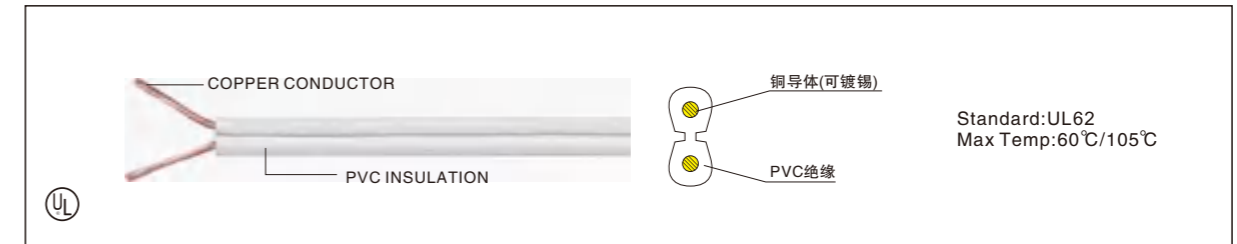

TYPE 型号	Conductor 导体		Insulation 绝缘体 Nom.thick(mm) 厚度	Approx. O.D 参考外径 (mm)
	AWG 线号	Construction (NO./mm) 结构		
SPT-1	18×2C	41/0.160	0.76	2.7×5.4
	18×3C	41/0.160	0.76	2.7×8.0
	18×2C	41/0.160	1.14	3.4×6.8
SPT-2	16×2C	65/0.160	1.14	3.7×7.4
	18×3C	41/0.160	1.14	3.5×8.6
	16×3C	65/0.160	1.14	3.8×9.6
SPT-3	18×2C	41/0.160	1.52	4.4×8.7
	16×2C	65/0.160	1.52	4.8×9.5
	14×2C	41/0.254	2.03	6.0×12.0
	12×2C	65/0.254	2.41	7.4×14.0
	10×2C	105/0.254	2.79	9.1×8.2
	18×3C	41/0.160	1.52	4.4×10.7
	16×3C	65/0.160	1.52	4.8×11.8
	14×3C	41/0.254	2.03	6.0×14.5
	12×3C	65/0.254	2.41	7.4×16.5
	10×3C	104/0.254	2.79	9.1×18.8

ST(W)、STO(W)、STOO(W)、SE(W)、SEO(W)、SEOO(W)

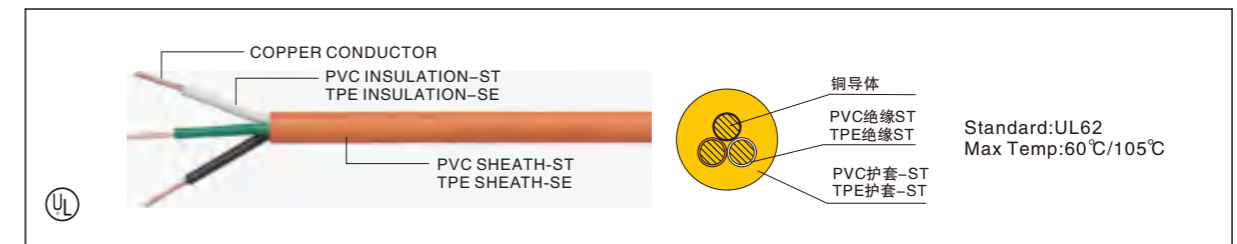

线号	Conductor Construction 导体结构	Insulation Thickness 绝缘厚度	Sheath Nom.thick 护套厚度	Approx.O.D 参考外径
AWG	(NO./mm)	(mm)	(mm)	(mm)
18×2C	41/0.16	0.76	1.52	9.0
16×2C	41/0.20	0.76	1.52	9.3
14×2C	41/0.254	1.14	2.03	11.4
12×2C	47/0.30	1.14	2.41	14.5
10×2C	74/0.30	1.14	2.41	15.6
18×3C	41/0.16	0.76	1.52	9.5
16×3C	41/0.20	0.76	1.52	9.9
14×3C	41/0.254	1.14	2.03	13.2
12×3C	47/0.30	1.14	2.41	15.0
10×3C	74/0.30	1.14	2.41	16.9

UI Flexible Cord And Fixture Wire



>> Cable & Wire

>> Cable & Wire

SJT(W)、SJTO(W)、SJTOO、SJE(W)、SJEOW)、SJEOW(W)

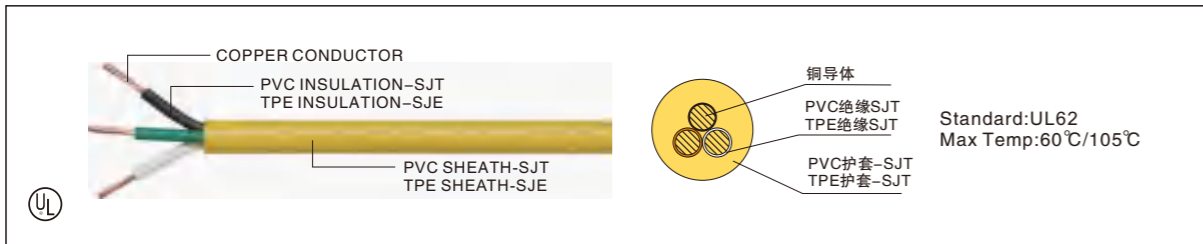

Conductor 导体		Insulation Thickness 绝缘厚度(mm)	Jacket Thickness 被覆厚度	Overall Diameter 完成外径(mm)
AWG 线号	(NO./mm) 线数/线径			
*18×2C	41/0.160	0.76	0.76	7.3±5.4
*16×2C	26/0.254			8.1±0.15
*14×2C	41/0.254			8.7±0.15
12×2C	65/0.254	1.14	0.76	9.9±0.15
10×3C	65/0.320			13.7±0.20
*18×3C	41/0.160			7.8±0.15
*16×3C	26/0.254	0.16	1.14	8.5±0.15
*14×3C	41/0.254			9.3±0.15
12×3C	65/0.254			10.8±12.0
10×3C	105/0.254	1.14	1.52	14.4±0.20

UI Flexible Cord And Fixture Wire

SVT、SVTO、SVTOO、SVE、SVEO、SVEOO

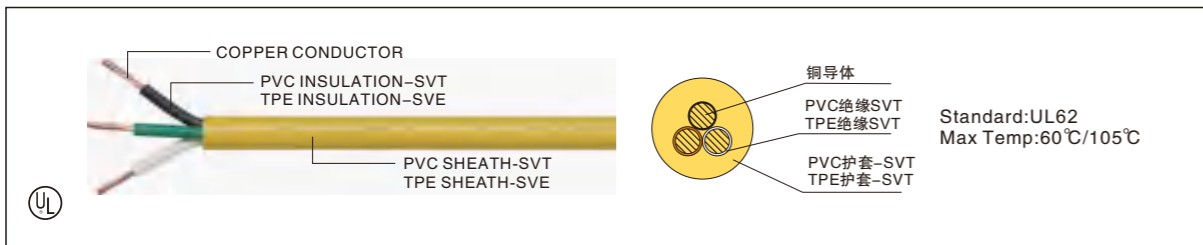

Conductor 导体		Insulation 绝缘体	Sheath 护套	Approx.O.D 参考外径
AWG 线号	Construction(NO./mm) 结构	Nom.thick(mm) 厚度	Nom.thick(mm) 厚度	
18×2C	41/0.160	0.38	0.76	5.9±0.10
16×2C	26/0.254	0.38	0.76	6.2±0.10
18×3C	41/0.160	0.38	0.76	6.3±0.10
16×3C	26/0.254	0.38	0.76	6.6±0.10

UI Flexible Cord And Fixture Wire

UL系列导线CONDUCTING WIRE SERIES

UI Flexible Cord And Fixture Wire

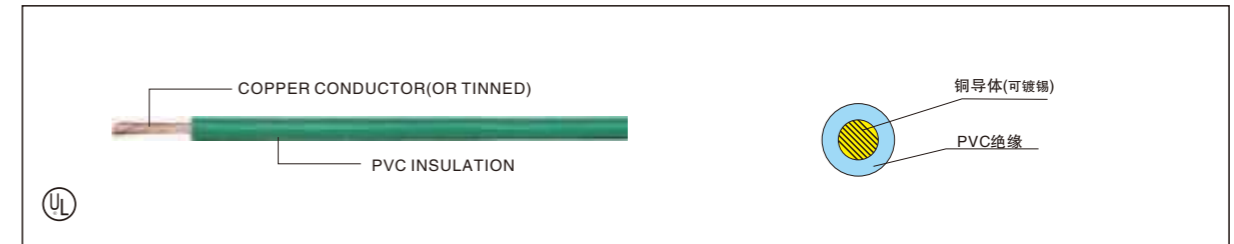

Model 型号	Rated temperature (°C) 额定温度	Tinning Copper Wire OS-1 镀铜锡线或OS-1		Wire Exradius(mm) 电线外径	
		Specifications (AGW)规格	(根/mm) Texture结构	Lowerlimit mm下限	Upperlimit mm上限
1013	90	26	8/0.15	3.08	3.69
		24	13/0.15	3.24	3.88
		22	19/0.15	3.38	4.05
		20	30/0.15	3.55	4.26
		18	47/0.15	3.82	4.58
		16	42/0.20	4.13	4.95
		14	66/0.20	4.63	5.55
		28	8/0.12	1.98	2.37
		26	8/0.15	2.08	2.49
		24	13/0.15	2.24	2.68
1618	80	22	19/0.15	2.38	2.85
		20	30/0.15	2.55	3.06
		18	47/0.15	2.82	3.38
		16	42/0.20	3.13	3.75
		14	66/0.20	3.62	4.35
		12	47/0.30	3.96	4.75
		10	75/0.30	4.57	5.48
		28	8/0.12	1.98	2.37
		26	8/0.15	2.08	2.49
		24	13/0.15	2.24	2.68
1500	105	22	19/0.15	2.38	2.85
		20	30/0.15	2.55	3.06
		18	47/0.15	2.82	3.38
		16	42/0.20	3.13	3.75
		14	66/0.20	3.63	4.35
		12	47/0.30	3.96	4.75
		10	75/0.30	4.57	5.48
		28	8/0.12	1.98	2.37
		26	8/0.15	2.08	2.49
		24	13/0.15	2.24	2.68
1007	80	22	19/0.15	2.38	2.85
		20	30/0.15	2.55	3.06
		18	47/0.15	2.82	3.38
		16	42/0.20	3.13	3.75
		28	8/0.12	1.16	1.39
		26	8/0.15	1.26	1.51
		24	13/0.15	1.42	1.7
		22	19/0.15	1.56	1.87
		20	30/0.15	1.73	2.07
		18	47/0.15	2	2.4



European Famous Brand

Power Cord



www.chinasy.net
 www.chinasy.en.alibaba.com
 www.globalsources.com/chinasy.co

>> Power Cord



SY-07 16A250~

H03VV-F	3G0.75mm ²	H05VV-F	3G0.75/1.0/1.5mm ²
H05RR-F	3G0.75/1.0/1.5mm ²	H05RN-F	3G0.75/1.0mm ²
H07RN-F	3G1.0/1.5mm ²		

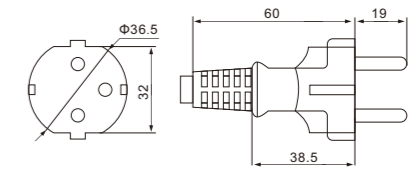

SY-08 16A250~

H03VV-F	3G0.75mm ²	H05VV-F	3G0.75/1.0/1.5mm ²
H05RR-F	3G0.75/1.0/1.5mm ²	H05RN-F	3G0.75/1.0mm ²
H07RN-F	3G1.0/1.5mm ²		

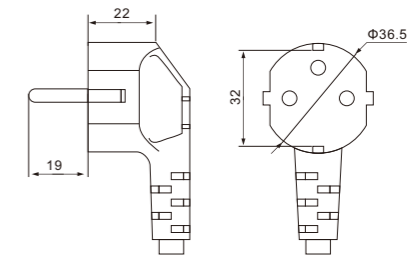

SY-42 16A250~

H05VV-F	3G1.0/1.5mm ²
---------	--------------------------

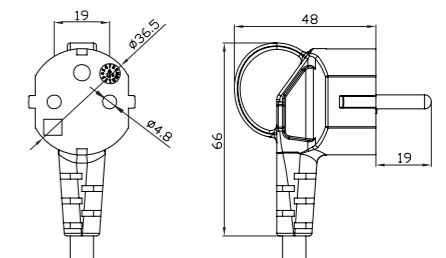



SY-09 16A 250~

H03VV-F	2×0.75mm ²	H05VV-F	2×0.75/1.0/1.5mm ²
H05RN-F	2×0.75/1.0mm ²	H07RN-F	2×1.5/2.5mm ²

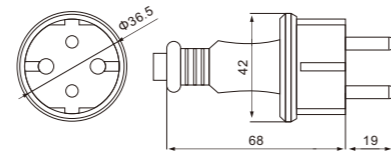

IP44



SY-11 16A 250~

H05RR-F	3G 0.75/1.0/1.5/2.5mm ²
H05RN-F	3G 0.75/1.0mm ²
H07RN-F	3G 1.0/1.5/2.5mm ²
H07BQ-F	3G 1.5/2.5mm ²
AT-N05V3V3-F	3G 1.0/1.5/2.5mm ²
AT-N07V3V3-F	3G 1.0/1.5/2.5mm ²

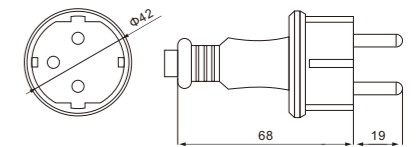

NF S D N IP44



SY-10 16A 250~

H03VV-F	2×0.75mm ²	H03VVH2-F	2×0.75mm ²
H05VV-F	2×0.75/1.0/1.5mm ²	H05VVH2-F	2×0.75/1.0mm ²
H05RR-F	2×0.75/1.0/1.5mm ²	H05RN-F	2×0.75/1.0mm ²

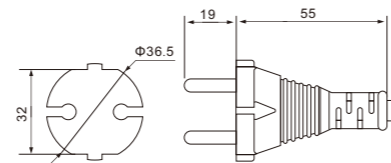

IP44



SY-31 16A 250~

H05RR-F	3G 0.75/1.0/1.5/2.5mm ²
H05RN-F	3G 0.75/1.0mm ²
H07RN-F	3G 1.0/1.5/2.5mm ²
H07BQ-F	3G 1.5/2.5mm ²
AT-N05V3V3-F	3G 1.0/1.5/2.5mm ²
AT-N07V3V3-F	3G 1.0/1.5/2.5mm ²

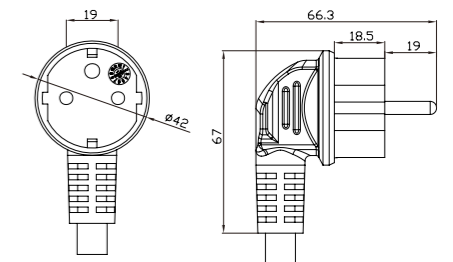

NF S IP44



SY-12 2.5A 250~

H03VVH2-F	2×0.5/0.75mm ²
H05VVH2-F	2×0.75/1.0mm ²

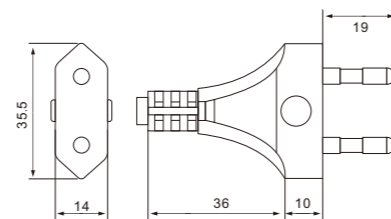

S D N IP44



SY-14 16A 250~

H03VV-F	2×0.75mm ²
H03VVH2-F	2×0.75mm ²
H05VV-F	2×0.75/1.0/1.5mm ²

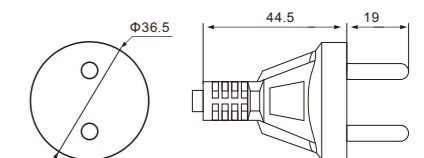

S D N

>> Power Cord



SY-20

4V-75 250/440V 3×0.75/1.0/1.5mm²
 4V-75 0.6/1KV 3×1.0/1.5mm²

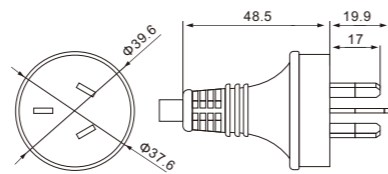

SY-24

H03VV-F 3G0.75mm² H05VV-F 3G0.75/1.0/1.5mm²
 H05RR-F 3G0.75/1.0/1.5mm² H07RN-F 3G0.75/1.0/1.5mm²

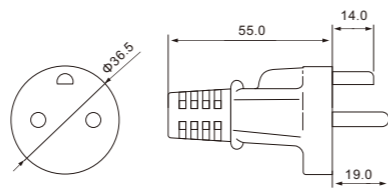

SY-28

H05VV-F 3G0.75/1.0/1.5mm²
 BS6500 3X1.25mm²

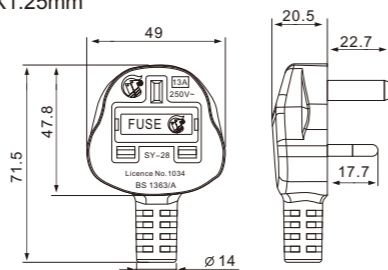

SY-30

10A 250~

H05VV-F 3G0.75/1.0/1.5mm²
 H05RR-F 3G1.0/1.5mm²
 H07RN-F 3G1.0/1.5mm²

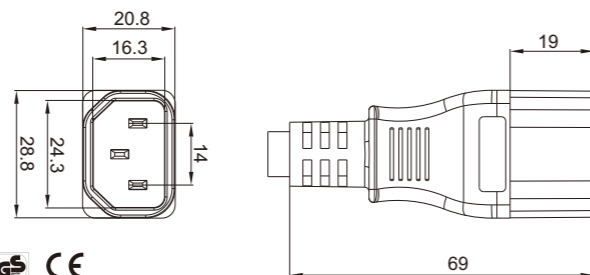

European Famous Brand

Assemble Plug & Socket





>> Assemble Plug & Socket

>> Assemble Plug & Socket

SY-CZ-60

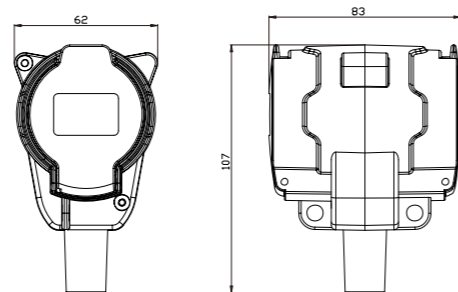

SY-29 16A 250~

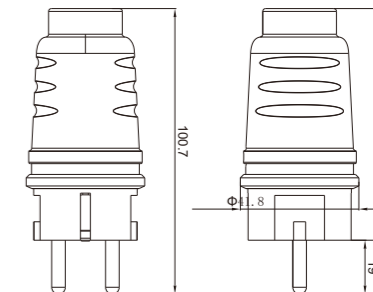

CE IP44

SY-CZ-61

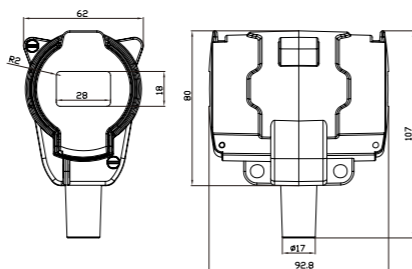

SY-CZ-29 16A 250~

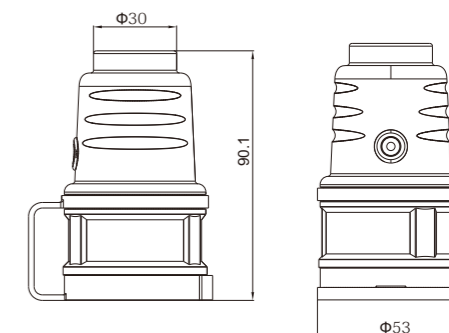

CE IP44

SY-CZ-28 13A 250~

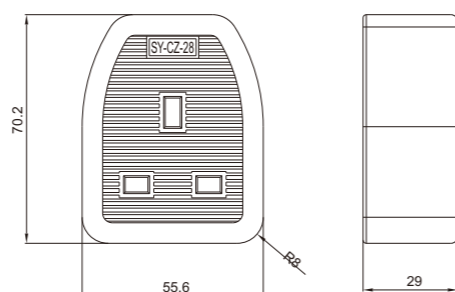

SY-32 16A 250~

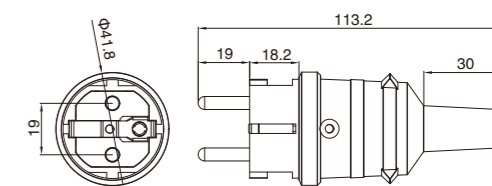

IP20

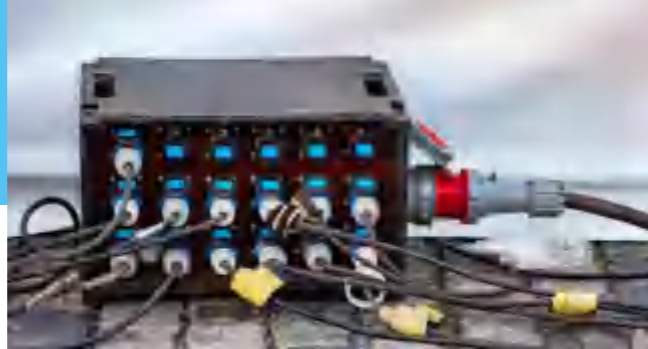

>> Assemble Plug & Socket

>> Assemble Plug & Socket



SY-CZ-32 16A 250~

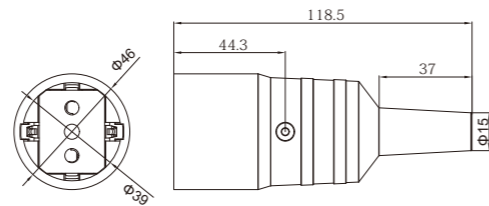

 IP20



EZ-13

13A 250V-IP44 BS1363

 IP44
England



SY-CZ-33 16A 250~

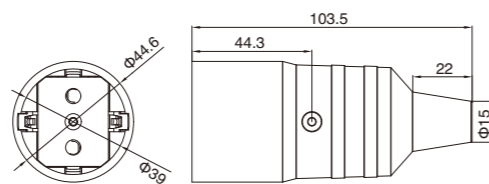

 IP20



EZ16

16A 250~

 IP44
Germany



SY-33

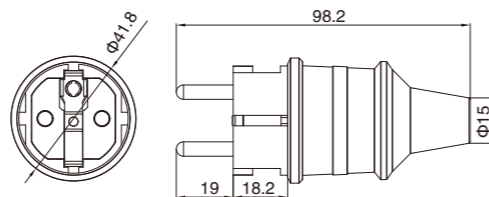

 IP20



EZ17

16A 250~MAX.3680W

 IP44
France



SY-34 16A 250~

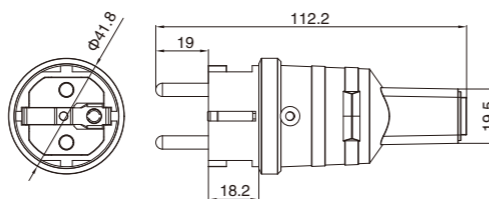

 IP20



>> Assemble Plug & Socket



EZ18

16A 250~MAX.3680W



Germany



IP44



EZ19

16A 250V~



Denmark

IP44



EZ20

USB O/P:DC 5V,Max 2.1A

CE IP44

European Famous Brand

Water-proof Box



>> **Water-proof Box**



FSH-01

Φ 6.5-Φ11
SIZE:216x87x85mm

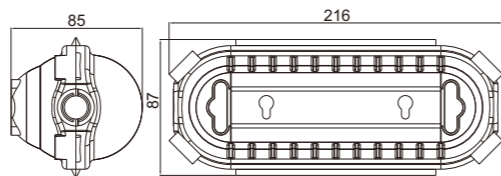

CE IP44



FSH-02

Φ 6.5-Φ12
SIZE:367x90x103mm

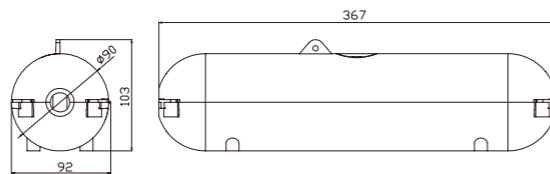

CE IP44

European Famous Brand

Extension Cord





>> Extension Cord

>> Extension Cord



SY-07/SY-CZ-01

H05VV-F 3G1.0/1.5mm²
H05RN-F 3G1.0mm²
H05RR-F 3G1.0/1.5mm²
H07RN-F 3G1.0/1.5mm²



SY-08/SY-CZ-02

H05VV-F 3G1.0/1.5mm²
H05RN-F 3G1.0mm²
H05RR-F 3G1.0/1.5mm²
H07RN-F 3G1.0/1.5mm²



SY-07/SY-CZ-02

H05VV-F 3G1.0/1.5mm²
H05RN-F 3G1.0mm²
H05RR-F 3G1.0/1.5mm²
H07RN-F 3G1.0/1.5mm²



SY-11/SY-CZ-05

H05RR-F 3G 0.75/1.0/1.5/2.5mm²
H05RN-F 3G 0.75/1.0mm²
H07RN-F 3G 1.0/1.5/2.5mm²
H07BQ-F 3G 1.5/2.5mm²
AT-N05V3V3-F 3G 1.0/1.5/2.5mm²
AT-N07V3V3-F 3G 1.0/1.5/2.5mm²



SY-08/SY-CZ-01

H05VV-F 3G1.0/1.5mm²
H05RN-F 3G1.0mm²
H05RR-F 3G1.0/1.5mm²
H07RN-F 3G1.0/1.5mm²



SY-11/SY-CZ-10

H05RN-F 3G1.0mm²
H05RR-F 3G1.0/1.5mm²
H07RN-F 3G1.0/1.5/2.5mm²





>> Extension Cord

>> Extension Cord



SY-11/SY-CZ-12

H05RN-F 3G1.0mm²
 H05RR-F 3G1.0/1.5mm²
 H07RN-F 3G1.0/1.5/2.5mm²

CE NF IP44



SY-20/SY-CZ-09

4V-75 250/440V 3G0.75/1.0/1.5mm²
 4V-75 0.6/1KV 3G1.0/1.5mm²



SY-11/SY-CZ-17

H05RN-F 3G1.0mm²
 H05RR-F 3G1.0/1.5mm²
 H07RN-F 3G1.0/1.5/2.5mm²

CE IP44



SY-24/SY-CZ-24

H05VV-F 3G1.0/1.5mm²
 H05RN-F 3G1.0mm²
 H05RR-F 3G1.0/1.5mm²
 H05RN-F 3G1.0/1.5mm²

D IP44



SY-28/SY-CZ-28

H05VV-F 3G1.0/1.5/2.5mm²
 H05RN-F 3G1.0mm²
 H05RR-F 3G1.0/1.5mm²
 H07RN-F 3G1.0/1.5/2.5mm²

CE IP44



SY-31/SY-CZ-05

H05RR-F 3G 0.75/1.0/1.5/2.5mm²
 H05RN-F 3G 0.75/1.0mm²
 H07RN-F 3G 1.0/1.5/2.5mm²
 H07BQ-F 3G 1.5/2.5mm²
 AT-N05V3V3-F 3G 1.0/1.5/2.5mm²
 AT-N07V3V3-F 3G 1.0/1.5/2.5mm²

Intertek CE IP44



>> Extension Cord

>> Extension Cord



SY-11/SY-CZ-18

H05RN-F 3G1.0mm²
H05RR-F 3G1.0/1.5mm²
H07RN-F 3G1.0/1.5/2.5mm²

CE IP44 



SY-11/SY-CZ-31

H07RN-F 3G1.5mm²



SY-08/SY-CZ-44

H05VV-F 3×1.0-1.5mm²

Intertek  CE 



EZ36/GP51

Industry socket(EZ36):
16A6H Cee 90° socket 200-250VAC 2P+E IP44

Industry plug(GP51):
16A6H 200-250VAC 2P+E IP44

Cable style:
H05VV-F 3G1.5-2.5mm²
H05RR-F 3G1.5-2.5mm²
H07RN-F 3G1.5-2.5mm²

IP44



SY-30/SY-CZ-30 10A 250~

H05VV-F 3G0.75/1.0/1.5mm²
H05RR-F 3G1.0/1.5mm²
H07RN-F 3G1.0/1.5mm²

CE IP44 



EZ35/GP51

Industry socket(EZ35):Cee 90° socket with Schuko socket
16A6H 200-250VAC 2P+E IP44

Industry plug(GP51)
16A6H 200-250VAC 2P+E IP44

Cable style:
H05VV-F 3G1.5-2.5mm²
H05RR-F 3G1.5-2.5mm²
H07RN-F 3G1.5-2.5mm²

IP44



>> Extension Cord

>> Extension Cord



3EZ-6H4D/GP51

H05RR-F 3×1.5-2.5mm²
H07RN-F 3×1.5-2.5mm²

CE IP44



EZ53/GP51

Industry socket(EZ53):
16A6H 200-250VAC 2P+E IP44

Industry plug(GP51):
16A6H 200-250VAC 2P+E IP44

Cable style:
H05VV-F 3G1.5-2.5mm²
H05RR-F 3G1.5-2.5mm²
H07RN-F 3G1.5-2.5mm²

IP44



EZ54/GP52

Industry socket(EZ54):
16A4H 100-130VAC 2P+E IP44

Industry plug(GP52):
16A4H 100-130VAC 2P+E IP44

Cable style:
H05VV-F 3G1.5-2.5mm²
H05RR-F 3G1.5-2.5mm²
H07RN-F 3G1.5-2.5mm²

IP44



EZ63/GP61

Industry socket(EZ63):
32A6H 200-250VAC 2P+E IP44

Industry plug(GP61):
32A6H 200-250VAC 2P+E IP44

Cable style:
H05VV-F 3G1.5-2.5mm²
H05RR-F 3G1.5-2.5mm²
H07RN-F 3G1.5-2.5mm²

IP44



EZ64/GP62

Industry socket(EZ64):
32A4H 100-130VAC 2P+E IP44

Industry plug(GP62):
32A4H 100-130VAC 2P+E IP44

Cable style:
H05VV-F 3G1.5-2.5mm²
H05RR-F 3G1.5-2.5mm²
H07RN-F 3G1.5-2.5mm²

IP44



EZ55/GP55

Industry socket(EZ55):
16A6H 200/346-240/415VAC 3P+N+E IP44

Industry plug(GP55):
16A6H 200/346-240/415VAC 3P+N+E IP44

Cable style:
H05VV-F 5G1.5mm² H05VV-F 5G2.5mm²
H05VV-F 5G4.0mm² H05VV-F 5G6.0mm²
H07RN-F 5G1.5mm² H07RN-F 5G2.5mm²
H07RN-F 5G4.0mm² H05VV-F 5G6.0mm²

IP44



>> Extension Cord

>> Extension Cord



SY-07/SY-CZ-41

H05VV-F 3×1.0-1.5mm²



SY-12/SY-CZ-15

H03VVH2-F 2×0.75mm²
H05VVH2-F 2×0.75mm²



SY-11/SY-CZ-42 (Schuko type) SY-11/SY-CZ-50 (German type new IP44) SY-11/SY-CZ-48 (French type)

H05RR-F 3×1.5-2.5mm²
H07RN-F 3×1.5-2.5mm²



SY-12/SY-CZ-45

H03VVH2-F 2×0.75mm²



SY-07/SY-CZ-43

H05VV-F 3×1.0-1.5mm²



SY-14/SY-CZ-03

H05VV-F 2×1.0mm²
H05VV-F 2×1.5mm²





>> Extension Cord

>> Extension Cord



TXB-03/SY-11

Four way extension sockets IP44
Schuko version

Cable style:
H05RN-F 3G1.0mm²
H05RR-F 3G1.5mm²
H07RN-F 3G1.0mm²
H07RN-F 3G1.5mm²
H07RN-F 3G2.5mm²



CE  IP44



TXB-06/SY-11

Two way extension sockets IP44
Schuko version

Cable style:
H05RN-F 3G1.0mm²
H05RR-F 3G1.5mm²
H07RN-F 3G1.0mm²
H07RN-F 3G1.5mm²
H07RN-F 3G2.5mm²



CE IP44



TXB-05/SY-11

Four way extension sockets IP44
French version

Cable style:
H05RN-F 3G1.0mm²
H05RR-F 3G1.5mm²
H07RN-F 3G1.0mm²
H07RN-F 3G1.5mm²
H07RN-F 3G2.5mm²



CE  IP44



TXB03-D/SY-11

Four way extension sockets IP44
Schuko version

Cable style:
H05RR-F 3G1.5mm²
H05RR-F 3G2.5mm²
H07RN-F 3G1.5mm²
H07RN-F 3G2.5mm²



CE



TXB-04/SY-11

Four way extension sockets IP44
French version

Cable style:
H05RN-F 3G1.0mm²
H05RR-F 3G1.5mm²
H07RN-F 3G1.0mm²
H07RN-F 3G1.5mm²
H07RN-F 3G2.5mm²



CE IP44



EZ35/SY-11

Industry socket(EZ35)
16A6H Anglo-German Style socket 200-250VAC 2P+E IP44

Cable style:
H05RN-F 3G1.0mm²
H05RR-F 3G1.5mm²
H07RN-F 3G1.0mm²
H07RN-F 3G1.5mm²
H07RN-F 3G2.5mm²
H05VV-F 3G1.5mm²
H05VV-F 3G1.0mm²

>> Extension Cord



>> Extension Cord



SY-CZ-10/GP51

Industry plug(GP51)
16A6H 200-250VAC 2P+E IP44

Cable style:
H05RN-F 3G1.0mm²
H05RR-F 3G1.5mm²
H07RN-F 3G1.0mm²
H07RN-F 3G1.5mm²
H07RN-F 3G2.5mm²
H05VV-F 3G1.5mm²
H05VV-F 3G1.0mm²



2EZ-4D\F\D\NN\E/SY-11

Two way extension sockets IP44
Schuko version

Cable style:
H05RR-F 3G1.5mm²
H05RR-F 3G2.5mm²
H07RN-F 3G1.5mm²
H07RN-F 3G2.5mm²

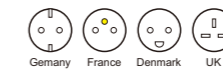

CE IP44



SY-CZ-12/GP51

Industry plug(GP51)
16A6H 200-250VAC 2P+E IP44

Cable style:
H05RN-F 3G1.0mm²
H05RR-F 3G1.5mm²
H07RN-F 3G1.0mm²
H07RN-F 3G1.5mm²
H07RN-F 3G2.5mm²
H05VV-F 3G1.5mm²
H05VV-F 3G1.0mm²



3EZ-4D\F\D\NN\E/SY-11

Three way extension sockets IP44
Schuko version

Cable style:
H05RR-F 3G1.5mm²
H05RR-F 3G2.5mm²
H07RN-F 3G1.5mm²
H07RN-F 3G2.5mm²

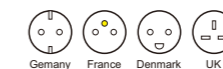

CE IP44



EZ53/SY-11

Industry socket(EZ53)
16A6H 200-250VAC 2P+E IP44

Cable style:
H05RN-F 3G1.0mm²
H05RR-F 3G1.5mm²
H07RN-F 3G1.0mm²
H07RN-F 3G1.5mm²
H07RN-F 3G2.5mm²
H05VV-F 3G1.5mm²
H05VV-F 3G1.0mm²



SY-11\SY-CZ-13-1 (Schuko type) SY-11\SY-CZ-49 (French type)

Three way French type extension sockets IP44
Schuko version

Cable style:
H05RR-F 3G1.5mm²
H05RR-F 3G2.5mm²
H07RN-F 3G1.5mm²
H07RN-F 3G2.5mm²

CE



>> Extension Cord

>> Extension Cord



SY-11/SY-CZ-13-2

H05RR-F 3×1.5-2.5mm²
H07RN-F 3×1.5-2.5mm²

   IP44



SY-CZ-35

Package	Q'ty/Ctn	G.W	N.W	Ctn Size	Q'ty/20'FT
Double blister(a)	20PCS	5.4kg	5kg	27×27×22CM	35625PCS



SY-11/SY-CZ-34

H05RR-F 3×1.5-2.5mm²
H07RN-F 3×1.5-2.5mm²

   IP44



SY-CZ-39

Package	Q'ty/Ctn	G.W	N.W	Ctn Size	Q'ty/20'FT
Double blister(a)	20PCS	5.4kg	5kg	27×27×22CM	35625PCS



SY-08/SY-CZ-19

H05VV-F 3G1.5mm²

 IP44  



SY-CZ-40

Package	Q'ty/Ctn	G.W	N.W	Ctn Size	Q'ty/20'FT
Double blister(a)	20PCS	4.7kg	4.3kg	25×25×21CM	43511PCS





European Famous Brand

Cable Organizer



www.chinasy.net
www.chinasy.en.alibaba.com
www.globalsources.com/chinasy.co

>> Cable Organizer



RXJ-01

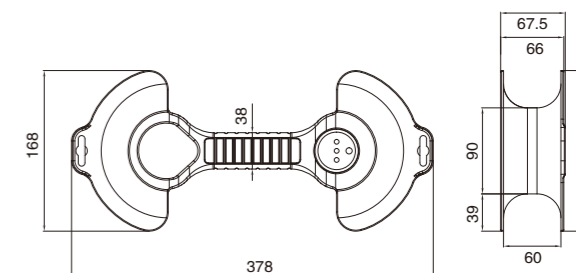

RXJ-02 Maximum weight 40KG

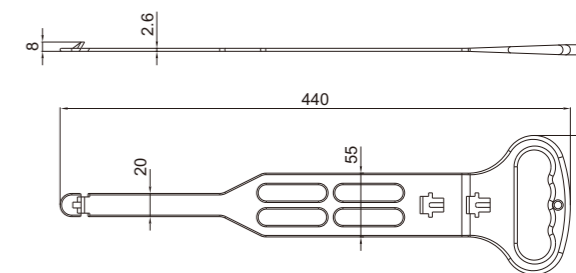

RXJ-06

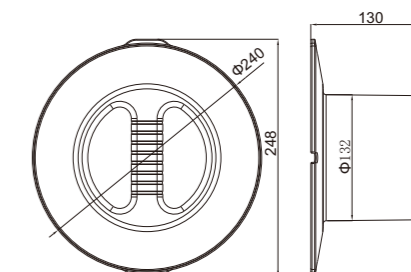

>> Cable Organizer



RXJ-07



Gift bag



European Famous Brand

Cable Reel





>> Cable Reel

>> Cable Reel



XP03-D\4D\F\NN

Match Cable	Max Meters	Full-reeled/ Unreeled	Waterproof of Rating
H05RR-F 3G1.0mm ²	30	1000W/2300W	IP44
H05RN-F 3G1.0mm ²	30	1000W/2300W	IP44
H05RR-F 3G1.5mm ²	25	1000W/3000W	IP44
H07RN-F 3G1.5mm ²	25	1000W/3000W	IP44



XP13-D\4D\F\NN

Match Cable	Max Meters	Full-reeled/ Unreeled	Waterproof of Rating
H05RR-F 3G1.0mm ²	40	900W/2300W	IP44
H05RN-F 3G1.0mm ²	40	900W/2300W	IP44
H05RR-F 3G1.5mm ²	25	1000W/3000W	IP44
H07RN-F 3G1.5mm ²	25	1000W/3000W	IP44

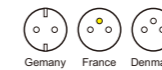

XP01-D\4D\F\NN

Match Cable	Max Meters	Full-reeled/ Unreeled	Waterproof of Rating
H05RR-F 3G1.0mm ²	40	1000W/2300W	IP44
H05RN-F 3G1.0mm ²	40	1000W/2300W	IP44
H05RR-F 3G1.5mm ²	50	1000W/3000W	IP44
H07RN-F 3G1.5mm ²	50	1000W/3000W	IP44
H07RN-F 3G2.5mm ²	40	1200W/3000W	IP44



XP14-D\4D\F\NN

Match Cable	Max Meters	Full-reeled/ Unreeled	Waterproof of Rating
H05RR-F 3G1.5mm ²	50	1000W/2300W	IP44
H07RN-F 3G1.5mm ²	50	1000W/2300W	IP44
H05RR-F 3G2.5mm ²	40	1200W/3600W	IP44
H07RN-F 3G2.5mm ²	40	1200W/3600W	IP44

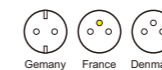

XP06-D\4D\F\NN

Match Cable	Max Meters	Full-reeled/ Unreeled	Waterproof of Rating
H05RR-F 3G1.0mm ²	40	1000W/2300W	IP44
H05RN-F 3G1.0mm ²	40	1000W/2300W	IP44
H05RR-F 3G1.5mm ²	50	1000W/3000W	IP44
H07RN-F 3G1.5mm ²	50	1000W/3000W	IP44
H07RN-F 3G2.5mm ²	40	1200W/3000W	IP44



XP16-D\4D\F\NN

Match Cable	Max Meters	Full-reeled/ Unreeled	Waterproof of Rating
H05RR-F 3G1.5mm ²	50	1000W/3000W	IP44
H07RN-F 3G1.5mm ²	50	1000W/3000W	IP44
H05RR-F 3G2.5mm ²	50	1200W/3600W	IP44
H07RN-F 3G2.5mm ²	40	1200W/3600W	IP44

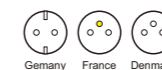



>> Cable Reel

>> Cable Reel



XP15-D\4D\F\NN

Match Cable	Max Meters	Full-reeled/Unreeled	Waterproof of Rating
H05RR-F 3G1.0mm ²	40	1000W/2300W	IP44
H05RN-F 3G1.0mm ²	40	1000W/2300W	IP44
H05RR-F 3G1.5mm ²	50	1000W/3000W	IP44
H07RN-F 3G1.5mm ²	50	1000W/3000W	IP44
H05RR-F 3G2.5mm ²	50	1200W/3600W	IP44
H07RN-F 3G2.5mm ²	40	1200W/3600W	IP44



XP03-D1\F1\NN1\U1\E1

Match Cable	Max Meters	Full-reeled/Unreeled	Waterproof of Rating
H05VV-F 3G1.0mm ²	40	1000W/2300W	IP20
H05VV-F 3G1.0mm ²	50	1000W/3000W	IP20

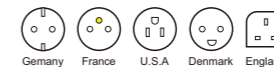

XP17-D\4D\F\NN

Match Cable	Max Meters	Full-reeled/Unreeled	Waterproof of Rating
H05RR-F 3G1.0mm ²	40	1000W/2300W	IP44
H05RN-F 3G1.0mm ²	40	1000W/2300W	IP44
H05RR-F 3G1.5mm ²	50	1000W/3000W	IP44
H07RN-F 3G1.5mm ²	50	1000W/3000W	IP44
H05RR-F 3G2.5mm ²	50	1200W/3600W	IP44
H07RN-F 3G2.5mm ²	40	1200W/3600W	IP44



XP01-D1\F1\NN1\U1\E1

Match Cable	Max Meters	Full-reeled/Unreeled	Waterproof of Rating
H05VV-F 3G1.5mm ²	50	1000W/3000W	IP20

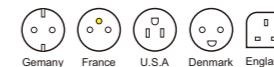

XP11-4D\4D\F\NN

Match Cable	Max Meters	Full-reeled/Unreeled	Waterproof of Rating
H05RR-F 3G1.5mm ²	15	1000W/3000W	IP44
H07RN-F 3G1.5mm ²	10	1000W/3000W	IP44



XP06-D1\F1\NN1\U1\E1

Match Cable	Max Meters	Full-reeled/Unreeled	Waterproof of Rating
H05VV-F 3G1.5mm ²	50	1000W/3000W	IP20

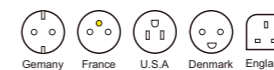



XP13-D1\F1\NN1\U1\E1

Match Cable	Max Meters	Full-reeled/ Unreeled	Waterproof of Rating
H05VV-F 3G1.0mm ²	40	900W/2300W	IP20



XP15-D1\F1\NN1\U1\E1

Match Cable	Max Meters	Full-reeled/ Unreeled	Waterproof of Rating
H05VV-F 3G1.0mm ²	40	1000W/2300W	IP20
H05VV-F 3G1.5mm ²	50	1000W/3000W	IP20

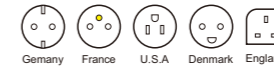

XP14-D1\F1\NN1\U1\E1

Match Cable	Max Meters	Full-reeled/ Unreeled	Waterproof of Rating
H05VV-F 3G1.5mm ²	50	1000W/3000W	IP20



XP17-D1\F1\NN1\U1\E1

Match Cable	Max Meters	Full-reeled/ Unreeled	Waterproof of Rating
H05VV-F 3G1.0mm ²	40	1000W/2300W	IP20
H05VV-F 3G1.5mm ²	50	1000W/3000W	IP20

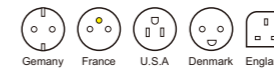

XP16-D1\F1\NN1\U1\E1

Match Cable	Max Meters	Full-reeled/ Unreeled	Waterproof of Rating
H05VV-F 3G1.5mm ²	50	1000W/3000W	IP20



XP11-D1\F1\NN1\U1\E1

Match Cable	Max Meters	Full-reeled/ Unreeled	Waterproof of Rating
H05VV-F 3G1.0mm ²	15	1000W/2300W	IP20
H05VV-F 3G1.5mm ²	15	1000W/3000W	IP20

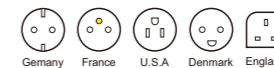



>> Cable Reel

>> Cable Reel



XP19-D1\F1\D2

Match Cable	Max Meters	Full-reeled/ Unreeled	Waterproof of Rating
H05VV-F 3G1.0mm ²	15	1000W/2300W	IP20
H05VV-F 3G1.5mm ²	10	1000W/3000W	IP20

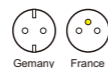

XP23-D2

Match Cable	Max Meters	Full-reeled/ Unreeled	Waterproof of Rating
H05VV-F 3G1.0mm ²	20	1000W/2300W	IP20
H05VV-F 3G1.5mm ²	15	1000W/3000W	IP20

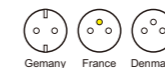

XP20-D1\F1\D2

Match Cable	Max Meters	Unreeled	Rating
H05VV-F 3G1.0mm ²	40	800W/2300W	IP20
H05VV-F 3G1.5mm ²	25	1000W/3000W	IP20

Size:202×177×295mm

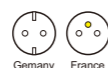

XP24-D1

Match Cable	Max Meters	Full-reeled/ Unreeled	Waterproof of Rating
H05VV-F 3G1.0mm ²	40	1000W/2300W	IP20
H05VV-F 3G1.5mm ²	50	1000W/3000W	IP20

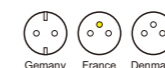

XP23-D1

Match Cable	Max Meters	Full-reeled/ Unreeled	Waterproof of Rating
H05VV-F 3G1.0mm ²	20	1000W/2300W	IP20
H05VV-F 3G1.5mm ²	15	1000W/3000W	IP20

Size:185×152×250mm



XP24-D2

Match Cable	Max Meters	Full-reeled/ Unreeled	Waterproof of Rating
H05VV-F 3G1.0mm ²	40	1000W/2300W	IP20
H05VV-F 3G1.5mm ²	50	1000W/3000W	IP20

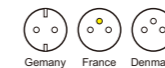



>> Cable Reel

>> Cable Reel



XP03-2E

Match Cable	Max Meters	Full-reeled/ Unreeled	Waterproof of Rating
H05VV-F 3G1.5mm ²	50	1000W/3000W	IP44
H05VV-F 3G1.25mm ²	50	1000W/3000W	IP44
H05RR-F 3G1.5mm ²	25	1000W/3000W	IP44
H07RN-F 3G1.5mm ²	25	1000W/3000W	IP44

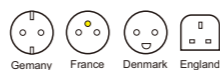

CE



XP03-W

Match Cable	Max Meters	Full-reeled/ Unreeled	Waterproof of Rating
H05RR-F 3G1.0mm ²	30	1000W/2300W	IP44
H05RN-F 3G1.0mm ²	30	1000W/2300W	IP44
H05RR-F 3G1.5mm ²	30	1000W/3000W	IP44
H05RN-F 3G1.5mm ²	30	1000W/3000W	IP44
H05RR-F 3G2.5mm ²	25	1200W/3600W	IP44
H07RN-F 3G2.5mm ²	25	1200W/3600W	IP44

CE



XP01-2E

Match Cable	Max Meters	Full-reeled/ Unreeled	Waterproof of Rating
H05VV-F 3G1.5mm ²	50	1000W/3000W	IP44
H05RR-F 3G1.5mm ²	50	1000W/3000W	IP44
H07RN-F 3G1.5mm ²	50	1000W/3000W	IP44
H05VV-F 3G2.5mm ²	50	1200W/3600W	IP44
H05RR-F 3G2.5mm ²	50	1200W/3600W	IP44
H07RN-F 3G2.5mm ²	40	1200W/3600W	IP44

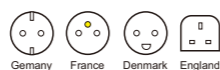

CE



XP01-W

Match Cable	Max Meters	Full-reeled/ Unreeled	Waterproof of Rating
H05RR-F 3G1.0mm ²	40	1000W/2300W	IP44
H05RN-F 3G1.0mm ²	40	1000W/2300W	IP44
H05RR-F 3G1.5mm ²	50	1000W/3000W	IP44
H05RN-F 3G1.5mm ²	50	1000W/3000W	IP44
H05RR-F 3G2.5mm ²	50	1200W/3600W	IP44
H07RN-F 3G2.5mm ²	50	1200W/3600W	IP44

CE



XP06-2E

Match Cable	Max Meters	Full-reeled/ Unreeled	Waterproof of Rating
H05VV-F 3G1.5mm ²	50	1000W/3000W	IP44
H05RR-F 3G1.5mm ²	50	1000W/3000W	IP44
H07RN-F 3G1.5mm ²	50	1000W/3000W	IP44
H05VV-F 3G2.5mm ²	50	1200W/3600W	IP44
H05RR-F 3G2.5mm ²	50	1200W/3600W	IP44
H07RN-F 3G2.5mm ²	40	1200W/3600W	IP44



CE



XP06-W

Match Cable	Max Meters	Full-reeled/ Unreeled	Waterproof of Rating
H05RR-F 3G1.0mm ²	40	1000W/2300W	IP44
H05RN-F 3G1.0mm ²	40	1000W/2300W	IP44
H05RR-F 3G1.5mm ²	50	1000W/3000W	IP44
H05RN-F 3G1.5mm ²	50	1000W/3000W	IP44
H05RR-F 3G2.5mm ²	50	1200W/3600W	IP44
H07RN-F 3G2.5mm ²	50	1200W/3600W	IP44

CE



XP06-3-4D\F\D\E\NN

Match Cable	Max Meters	Full-reeled/ Unreeled	Waterproof of Rating
H05RR-F 3G1.5mm ²	50	1000W/3000W	IP44
H07RN-F 3G1.5mm ²	50	1000W/3000W	IP44
H05RR-F 3G2.5mm ²	50	1200W/3600W	IP44
H07RN-F 3G2.5mm ²	40	1200W/3600W	IP44



XP06-1EZ51-4D\F\D\NN\E

Match Cable	Max Meters	Full-reeled/ Unreeled	Waterproof of Rating
H05RR-F 3G2.5mm ²	50	1200W/3000W	IP44
H07RN-F 3G2.5mm ²	40	1200W/3000W	IP44

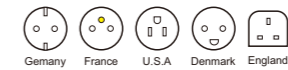

XP03-SY4H

Match Cable	Max Meters	Full-reeled/ Unreeled	Waterproof of Rating
H05VV-F 3G1.5mm ²	50	660W/1760W	IP44
H05RR-F 3G1.5mm ²	25	660W/1760W	IP44
H07RN-F 3G1.5mm ²	25	660W/1760W	IP44



XP06-2EZ51-4D\F\D\NN\E

Match Cable	Max Meters	Full-reeled/ Unreeled	Waterproof of Rating
H05RR-F 3G2.5mm ²	50	1200W/3600W	IP44
H07RN-F 3G2.5mm ²	40	1200W/3600W	IP44



XP03-SY6H

Match Cable	Max Meters	Full-reeled/ Unreeled	Waterproof of Rating
H05VV-F 3G1.5mm ²	50	720W/3680W	IP44
H05RR-F 3G1.5mm ²	25	720W/3680W	IP44
H07RN-F 3G1.5mm ²	25	720W/3680W	IP44



XP06-SY51-4D\F\D\NN\E

Match Cable	Max Meters	Full-reeled/ Unreeled	Waterproof of Rating
H05RR-F 3G2.5mm ²	25	1200W/3600W	IP44
H07RN-F 3G2.5mm ²	20	1200W/3600W	IP44





>> Cable Reel

>> Cable Reel



XP06-SY52-4D\F\D\N\N\E

Match Cable	Max Meters	Full-reeled/ Unreeled	Waterproof of Rating
H05RR-F 3G2.5mm ²	25	1200W/3600W	IP44
H07RN-F 3G2.5mm ²	20	1200W/3600W	IP44



XP03-E1U

Match Cable	Max Meters	Full-reeled/ Unreeled	Waterproof of Rating
H05VV-F 3G1.0mm ²	40	1000W/2300W	IP20
H05VV-F 3G1.0mm ²	50	1000W/3000W	IP20

USB O/P:DC 5V,Max 2.1A



XP15-1EZ51-4D/D/F/E/NN

Match Cable	Max Meters	Full-reeled/ Unreeled	Waterproof of Rating
H05RR-F 3G1.0mm ²	40	1000W/2300W	IP44
H05RN-F 3G1.0mm ²	40	1000W/2300W	IP44
H05RR-F 3G1.5mm ²	50	1000W/3000W	IP44
H07RN-F 3G1.5mm ²	50	1000W/3000W	IP44
H05RR-F 3G2.5mm ²	50	1200W/3600W	IP44
H07RN-F 3G2.5mm ²	40	1200W/3600W	IP44



CE IP44



XP06-DIU

Match Cable	Max Meters	Full-reeled/ Unreeled	Waterproof of Rating
H05VV-F 3G1.5mm ²	50	1000W/3000W	IP20

USB O/P:DC 5V,Max 2.1A

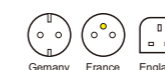

XP01-F1U

Match Cable	Max Meters	Full-reeled/ Unreeled	Waterproof of Rating
H05VV-F 3G1.5mm ²	50	1000W/3000W	IP20

USB O/P:DC 5V,Max 2.1A



CE



XP06-3-4DU

Match Cable	Max Meters	Full-reeled/ Unreeled	Waterproof of Rating
H05RR-F 3G1.0mm ²	40	1000W/2300W	IP44
H05RN-F 3G1.0mm ²	40	1000W/2300W	IP44
H05RR-F 3G1.5mm ²	50	1000W/3000W	IP44
H07RN-F 3G1.5mm ²	50	1000W/3000W	IP44
H05RR-F 3G2.5mm ²	50	1200W/3600W	IP44
H07RN-F 3G2.5mm ²	40	1200W/3600W	IP44

USB O/P:DC 5V,Max 2.1A



IP44

>> Cable Reel



>> Cable Reel



XP06-1EZ51-4DU

Match Cable	Max Meters	Full-reeled/Unreeled	Waterproof of Rating
H05RR-F 3G1.0mm ²	40	1000W/2300W	IP44
H05RN-F 3G1.0mm ²	40	1000W/2300W	IP44
H05RR-F 3G1.5mm ²	50	1000W/3000W	IP44
H07RN-F 3G1.5mm ²	50	1000W/3000W	IP44
H05RR-F 3G2.5mm ²	50	1200W/3600W	IP44
H07RN-F 3G2.5mm ²	40	1200W/3600W	IP44

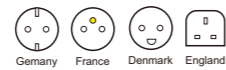

USB O/P:DC 5V,Max 2.1A

CE IP44



XP20-E1

Match Cable	Max Meters	Full-reeled/Unreeled	Waterproof of Rating
H05VV-F 3G1.0mm ²	40	800W/2300W	IP20
A05VV-F 3G1.25mm ²	25	1000W/3000W	IP20
H05VV-F 3G1.5mm ²	25	1000W/3000W	IP20



CE



XP06-NN3

Match Cable	Max Meters	Full-reeled/Unreeled	Waterproof of Rating
H05VV-F 3G1.0mm ²	40	1000W/2300W	IP20
H05VV-F 3G1.5mm ²	50	1000W/3000W	IP20



CE



XP23-D2

Match Cable	Max Meters	Full-reeled/Unreeled	Waterproof of Rating
H05VV-F 3G1.5mm ²	15	1000W/3000W	IP20
A05VV-F 3G1.25mm ²	15	1000W/3000W	IP20

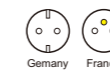

CE



XP23-E1

Match Cable	Max Meters	Full-reeled/Unreeled	Waterproof of Rating
H05VV-F 3G1.5mm ²	15	1000W/3000W	IP20
A05VV-F 3G1.25mm ²	15	1000W/3000W	IP20



CE



XP19-E1

Match Cable	Max Meters	Full-reeled/Unreeled	Waterproof of Rating
H05VV-F 3G1.0mm ²	15	1000W/2300W	IP20
H05VV-F 3G1.5mm ²	10	1000W/3000W	IP20

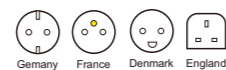

CE



XP27-D1

Match Cable	Max Meters	Full-reeled/Unreeled	Waterproof of Rating
H05VV-F 2G1.5mm ²	10	1000W/3000W	IP20
H05VV-F 3G1.0mm ²	15	900W/2300W	IP20
A05VV-F 3G1.25mm ²	10	1000W/3000W	IP20
H05VV-F 3G1.5mm ²	10	1000W/3000W	IP20



XP28-D1

Match Cable	Max Meters	Full-reeled/Unreeled	Waterproof of Rating
H05VV-F 2G1.5mm ²	30	900W/2300W	IP20
H05VV-F 3G1.0mm ²	40	900W/2300W	IP20
A05VV-F 3G1.25mm ²	30	1000W/3000W	IP20
H05VV-F 3G1.5mm ²	30	1000W/3000W	IP20
H05RR-F 3G1.0mm ²	30	900W/2300W	IP44
H05RR-F 3G1.5mm ²	25	1000W/3000W	IP44
H07RN-F 3G1.0mm ²	25	900W/2300W	IP44
H07RN-F 3G1.5mm ²	20	1000W/3000W	IP44

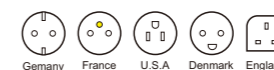

XP27-E1

Match Cable	Max Meters	Full-reeled/Unreeled	Waterproof of Rating
H05VV-F 2G1.5mm ²	10	1000W/3000W	IP20
H05VV-F 3G1.0mm ²	15	900W/2300W	IP20
A05VV-F 3G1.25mm ²	10	1000W/3000W	IP20
H05VV-F 3G1.5mm ²	10	1000W/3000W	IP20



XP28-E1

Match Cable	Max Meters	Full-reeled/Unreeled	Waterproof of Rating
H05VV-F 2G1.5mm ²	30	1000W/3000W	IP20
H05VV-F 3G1.0mm ²	40	900W/2300W	IP20
A05VV-F 3G1.25mm ²	30	1000W/3000W	IP20
H05VV-F 3G1.5mm ²	30	1000W/3000W	IP20
H05RR-F 3G1.0mm ²	30	900W/2300W	IP44
H05RR-F 3G1.5mm ²	25	1000W/3000W	IP44
H07RN-F 3G1.0mm ²	25	900W/2300W	IP44
H07RN-F 3G1.5mm ²	20	1000W/3000W	IP44



XP27-E1-4

Match Cable	Max Meters	Full-reeled/Unreeled	Waterproof of Rating
H05VV-F 2G1.5mm ²	10	1000W/3000W	IP20
H05VV-F 3G1.0mm ²	15	900W/2300W	IP20
A05VV-F 3G1.25mm ²	10	1000W/3000W	IP20
H05VV-F 3G1.5mm ²	10	1000W/3000W	IP20





XP29-D1

Match Cable	Max Meters	Full-reeled/ Unreeled	Waterproof of Rating
H05VV-F 2G1.5mm ²	6	1000W/3000W	IP20
H05VV-F 3G1.0mm ²	6	900W/2300W	IP20
A05VV-F 3G1.25mm ²	6	1000W/3000W	IP20
H05VV-F 3G1.5mm ²	6	1000W/3000W	IP20



XP29-E1

Match Cable	Max Meters	Full-reeled/ Unreeled	Waterproof of Rating
H05VV-F 2G1.5mm ²	6	1000W/3000W	IP20
H05VV-F 3G1.0mm ²	6	900W/2300W	IP20
A05VV-F 3G1.25mm ²	6	1000W/3000W	IP20
H05VV-F 3G1.5mm ²	6	1000W/3000W	IP20





EZ35

NAME	POWER	POLES	WATERPROOF RATING
Cee 90° with Schuko socket	200-250V~16A-6H	2P+E	IP44

CE



EZ52

NAME	POWER	POLES	WATERPROOF RATING
16A6H wall socket	100-130V~16A-4H	2P+E	IP44

CE



EZ37-D/F/E/NN

NAME	POWER	POLES	WATERPROOF RATING
Cee 90° with Schuko socket	200-250V~16A-6H	2P+E	IP44

CE



EZ53

NAME	POWER	POLES	WATERPROOF RATING
16A6H socket	200-250V~16A-6H	2P+E	IP44

CE



EZ51

NAME	POWER	POLES	WATERPROOF RATING
16A6H wall socket	200-250V~16A-6H	2P+E	IP44

CE



EZ53-M

NAME	POWER	POLES	WATERPROOF RATING
16A6H socket	200-250V~16A-6H	2P+E	IP44

CE

>> Industrial Plug



>> Industrial Plug



EZ54

NAME	POWER	POLES	WATERPROOF RATING
16A4H socket	100-130V~16A-4H	2P+E	IP44



EZ55-M

NAME	POWER	POLES	WATERPROOF RATING
16A5-pin socket	200/346-240/415V~16A-6H	3P+N+E	IP44



EZ54-M

NAME	POWER	POLES	WATERPROOF RATING
16A4H socket	100-130V~16A-4H	2P+E	IP44



EZ56

NAME	POWER	POLES	WATERPROOF RATING
16A5-pin wall socket	200/346-240/415V~16A-6H	3P+N+E	IP44



EZ55

NAME	POWER	POLES	WATERPROOF RATING
16A 5-pin socket	200/346-240/415V~16A-6H	3P+N+E	IP44



EZ61

NAME	POWER	POLES	WATERPROOF RATING
32A6H wall socket	200-250V~32A-6H	2P+E	IP44





EZ62



NAME	POWER	POLES	WATERPROOF RATING
32A4H wall socket	100-130V~32A-4H	2P+E	IP44

CE

EZ64



NAME	POWER	POLES	WATERPROOF RATING
32A4H socket	100-130V~32A-4H	2P+E	IP44

CE

EZ63



NAME	POWER	POLES	WATERPROOF RATING
32A6H wall socket	200-250V~32A-6H	2P+E	IP44

CE

EZ62-M



NAME	POWER	POLES	WATERPROOF RATING
32A4H socket	100-130V~32A-4H	2P+E	IP44

CE

EZ63-M



NAME	POWER	POLES	WATERPROOF RATING
32A6H socket	200-250V~32A-6H	2P+E	IP44

CE

GP35



NAME	POWER	POLES	WATERPROOF RATING
Industrial 16A 90° Plug	200-250V~16A-6H	2P+E	IP44

CE

>> Industrial Plug



>> Industrial Plug



GP51

NAME	POWER	POLES	WATERPROOF RATING
16A6H plug	200-250V~16A-6H	2P+E	IP44



GP52-M

NAME	POWER	POLES	WATERPROOF RATING
16A4H plug	100-130V~16A-4H	2P+E	IP44



GP51-M

NAME	POWER	POLES	WATERPROOF RATING
16A6H plug	200-250V~16A-6H	2P+E	IP44



GP53

NAME	POWER	POLES	WATERPROOF RATING
16A6H wall plug	200-250V~16A-6H	2P+E	IP44



GP52

NAME	POWER	POLES	WATERPROOF RATING
16A4H socket	100-130V~16A-4H	2P+E	IP44



GP54

NAME	POWER	POLES	WATERPROOF RATING
16A4H wall plug	100-130V~16A-4H	2P+E	IP44



>> Industrial Plug



>> Industrial Plug



GP55



NAME	POWER	POLES	WATERPROOF RATING
5-pin socket 16A	200/346- 240/415V~16A-6H	3P+N+E	IP44



GP61-M



NAME	POWER	POLES	WATERPROOF RATING
32A6H plug	200-250V~32A-6H	2P+E	IP44



GP55-M



NAME	POWER	POLES	WATERPROOF RATING
5-pin socket	200/346- 240/415V~16A-6H	3P+N+E	IP44



GP62



NAME	POWER	POLES	WATERPROOF RATING
32A4H plug	100-130V~32A-4H	2P+E	IP44



GP61



NAME	POWER	POLES	WATERPROOF RATING
32A6H plug	200-250V~32A-6H	2P+E	IP44



GP62-M



NAME	POWER	POLES	WATERPROOF RATING
32A4H plug	100-130V~32A-4H	2P+E	IP44





GP51-4D\F\D\NN

NAME	POWER	POLES	WATERPROOF RATING
Cee plug to Germany socket	200-250V~16A-6H	2P+E	IP44

CE  IP44



GP41

NAME	POWER	POLES	WATERPROOF RATING
16A plug	200-250V~16A-9H	3P+E	IP44

CE  IP44



GP51-E

NAME	POWER	POLES	WATERPROOF RATING
Cee plug to UK plug	200-250V~16A-6H	2P+E	IP44

CE IP44



EZ41

NAME	POWER	POLES	WATERPROOF RATING
16A socket	200-250V~16A-9H	3P+E	IP44

CE  IP44



GP53-4D

NAME	POWER	POLES	WATERPROOF RATING
Cee plug to Germany plug	200-250V~16A-6H	2P+E	IP44

CE IP44



EZ57

NAME	POWER	POLES	WATERPROOF RATING
5-pin socket 16A	200/346-240/415V~16A-6H	3P+N+E	IP44



GP57



NAME	POWER	POLES	WATERPROOF RATING
5-pin plug 16A	2200/346- 240/415V~16A-6H	3P+N+E	IP44

△ CE IP44

GP07



NAME	POWER	POLES	WATERPROOF RATING
16A6H plug	200-250V~16A-6H	2P+E	IP44

GP58 Phanse change



NAME	POWER	POLES	WATERPROOF RATING
5-pin plug 16A	200/346- 240/415V~16A-6H	3P+N+E	IP44

△ CE IP44

EZ08



NAME	POWER	POLES	WATERPROOF RATING
16A4H socket	100-130V~16A-4H	2P+E	IP44

△ CE IP44

EZ07



NAME	POWER	POLES	WATERPROOF RATING
16A6H socket	200-250V~16A-6H	2P+E	IP44

△ CE IP44

GP08



NAME	POWER	POLES	WATERPROOF RATING
16A4H plug	100-130V~16A-4H	2P+E	IP44

△ CE IP44

>> Industrial Plug



>> Industrial Plug



EZ53-M2



NAME	POWER	POLES	WATERPROOF RATING
16A6H socket	100-130V~16A-4H	2P+E	IP44

CE

GP52-M2



NAME	POWER	POLES	WATERPROOF RATING
16A4H plug	100-130V~16A-4H	2P+E	IP44

CE

EZ54-M2



NAME	POWER	POLES	WATERPROOF RATING
16A4H socket	100-130V~16A-4H	2P+E	IP44

CE

2EZ-6H



NAME	POWER	POLES	WATERPROOF RATING
16A6H socket	200-250V~16A-6H	2P+E	IP44

CE

GP51-M2



NAME	POWER	POLES	WATERPROOF RATING
16A6H socket	200-250V~16A-6H	2P+E	IP44

CE

2EZ-4H



NAME	POWER	POLES	WATERPROOF RATING
16A4H socket	100-130V~16A-4H	2P+E	IP44

CE

>> Industrial Plug



3EZ-6H

NAME	POWER	POLES	WATERPROOF RATING
16A6H socket	200-250V~16A-6H	2P+E	IP44



3EZ-4H

NAME	POWER	POLES	WATERPROOF RATING
16A4H socket	100-130V~16A-4H	2P+E	IP44



3EZ-6H-2

NAME	POWER	POLES	WATERPROOF RATING
16A6H socket	200-250V~16A-6H	2P+E	IP44



3EZ-4H-2

NAME	POWER	POLES	WATERPROOF RATING
16A4H socket	100-130V~16A-4H	2P+E	IP44



European Famous Brand

Extension Sockets





>> Extension Sockets

>> Extension Sockets



TXB01-4D/SY-11

Three way extension sockets IP44
Schuko version

Cable style:
H05RN-F 3G1.0mm²
H05RR-F 3G1.5mm²
H07RN-F 3G1.0mm²
H07RN-F 3G1.5mm²
H07RN-F 3G2.5mm²



TXB01-F/GP51

Three way extension sockets IP44
Cee industry: 16A6H 200-250VAC 2P+E IP44

Cable style:
H05RN-F 3G1.0mm²
H05RR-F 3G1.5mm²
H07RN-F 3G1.0mm²
H07RN-F 3G1.5mm²
H07RN-F 3G2.5mm²



TXB01-F/SY-11

Three way extension sockets IP44
French version

Cable style:
H05RN-F 3G1.0mm²
H05RR-F 3G1.5mm²
H07RN-F 3G1.0mm²
H07RN-F 3G1.5mm²
H07RN-F 3G2.5mm²



TXB12-4D/SY-11

Four way extension sockets IP44
Schuko version

Cable style:
H05RN-F 3G1.0mm²
H05RR-F 3G1.5mm²
H07RN-F 3G1.0mm²
H07RN-F 3G1.5mm²
H07RN-F 3G2.5mm²



TXB01-4D/GP51

Three way extension sockets IP44
Cee industry: 16A6H 200-250VAC 2P+E IP44

Cable style:
H05RN-F 3G1.0mm²
H05RR-F 3G1.5mm²
H07RN-F 3G1.0mm²
H07RN-F 3G1.5mm²
H07RN-F 3G2.5mm²



TXB12-F/SY-11

Four way extension sockets IP44
French version

Cable style:
H05RN-F 3G1.0mm²
H05RR-F 3G1.5mm²
H07RN-F 3G1.0mm²
H07RN-F 3G1.5mm²
H07RN-F 3G2.5mm²





>> Extension Sockets

>> Extension Sockets



TXB-2-F/D/4D

TXB-2-F Cable style:
H05RRR-F 3G1.5-2.5mm² Min 1.4m
H07RRR-F 3G1.5-2.5mm² Min 1.4m

TXB-2-D Cable style:
H05RRR-F 3G1.5-2.5mm² Min 1.4-30m Max.
H07RRR-F 3G1.5-2.5mm² Min 1.4-30m Max.

TXB-2-4D Cable style:
H05RRR-F 3G1.5-2.5mm² Min 1.4-30m Max.
H07RRR-F 3G1.5-2.5mm² Min 1.4-30m Max.



TXB-5-F/D/4D

TXB-5-F Cable style:
H05RRR-F 3G1.5-2.5mm² Min 1.4m
H07RRR-F 3G1.5-2.5mm² Min 1.4m

TXB-5-D Cable style:
H05RRR-F 3G1.5-2.5mm² Min 1.4-30m Max.
H07RRR-F 3G1.5-2.5mm² Min 1.4-30m Max.

TXB-5-4D Cable style:
H05RRR-F 3G1.5-2.5mm² Min 1.4-30m Max.
H07RRR-F 3G1.5-2.5mm² Min 1.4-30m Max.



TXB-3-F/D/4D

TXB-3-F Cable style:
H05RRR-F 3G1.5-2.5mm² Min 1.4m
H07RRR-F 3G1.5-2.5mm² Min 1.4m

TXB-3-D Cable style:
H05RRR-F 3G1.5-2.5mm² Min 1.4-30m Max.
H07RRR-F 3G1.5-2.5mm² Min 1.4-30m Max.

TXB-3-4D Cable style:
H05RRR-F 3G1.5-2.5mm² Min 1.4-30m Max.
H07RRR-F 3G1.5-2.5mm² Min 1.4-30m Max.



TXB-6-F/D/4D

TXB-6-F Cable style:
H05RRR-F 3G1.5-2.5mm² Min 1.4m
H07RRR-F 3G1.5-2.5mm² Min 1.4m

TXB-6-D Cable style:
H05RRR-F 3G1.5-2.5mm² Min 1.4-30m Max.
H07RRR-F 3G1.5-2.5mm² Min 1.4-30m Max.

TXB-6-4D Cable style:
H05RRR-F 3G1.5-2.5mm² Min 1.4-30m Max.
H07RRR-F 3G1.5-2.5mm² Min 1.4-30m Max.



TXB-4-F/D/4D

TXB-4-F Cable style:
H05RRR-F 3G1.5-2.5mm² Min 1.4m
H07RRR-F 3G1.5-2.5mm² Min 1.4m

TXB-4-D Cable style:
H05RRR-F 3G1.5-2.5mm² Min 1.4-30m Max.
H07RRR-F 3G1.5-2.5mm² Min 1.4-30m Max.

TXB-4-4D Cable style:
H05RRR-F 3G1.5-2.5mm² Min 1.4-30m Max.
H07RRR-F 3G1.5-2.5mm² Min 1.4-30m Max.



DZ11

H05RR-F 3G 0.75/1.0/1.5/2.5mm²
H05RN-F 3G 0.75/1.0mm²
H07RN-F 3G 1.0/1.5/2.5mm²
H07BQ-F 3G 1.5/2.5mm²
AT-N05V3V3-F 3G 1.0/1.5/2.5mm²
AT-N07V3V3-F 3G 1.0/1.5/2.5mm²





>> Extension Sockets

>> Extension Sockets



TXB-2K-4D/D

Cable style:
H05RR-F 3G1.5-2.5mm² Min 1.4-30m Max.
H07RN-F 3G1.5-2.5mm² Min 1.4-30m Max.

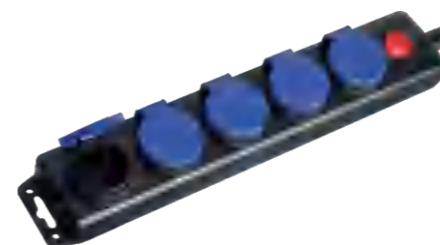

TXB-5K-4D/D/F

Cable style:
H05RR-F 3G1.5-2.5mm² Min 1.4-30m Max.
H07RN-F 3G1.5-2.5mm² Min 1.4-30m Max.



TXB-3K-4D/D/F

Cable style:
H05RR-F 3G1.5-2.5mm² Min 1.4-30m Max.
H07RN-F 3G1.5-2.5mm² Min 1.4-30m Max.



TXB-6K-4D/D

Cable style:
H05RR-F 3G1.5-2.5mm² Min 1.4-30m Max.
H07RN-F 3G1.5-2.5mm² Min 1.4-30m Max.



TXB-4K-4D/D/F

Cable style:
H05RR-F 3G1.5-2.5mm² Min 1.4-30m Max.
H07RN-F 3G1.5-2.5mm² Min 1.4-30m Max.



TXB16-4DU

USB O/P:DC 5V,Max 2.1A

Cable style:
H05RR-F 3G1.5-2.5mm² Min 1.4-30m Max.
H07RN-F 3G1.5-2.5mm² Min 1.4-30m Max.



>> Gardenspikes Sockets



>> Gardenspikes Sockets



SYH05-4D

2 WAY SOCKETS WITH 24HOURS TIMER ON BACKSIDE

Cable type:H07RN-F3G1.5/2.5mm²
H05RR-F3G1.5mm²

Sweden version:SYH05-4D
DK version:SYH05-NN
German version:SYH05-D
French version:SYH05-F
U.K. version:SYH05-E

Approval:CE/GS/S/ROHS



SYH06-4D/D/F/E/NN

2 WAY SOCKETS WITH 24HOURS TIMER ON BACKSIDE

Cable type:H07RN-F3G1.5/2.5mm²
H05RR-F3G1.5mm²

Sweden version:SYH05-4D
DK version:SYH05-NN
German version:SYH05-D
French version:SYH05-F
U.K. version:SYH05-E

Approval:CE/GS/S/ROHS



SYH02-4D

2 WAY SOCKETS WITHOUT TIME

Cable type:H07RN-F3G1.5/2.5mm²
H05RR-F3G1.5mm²

Sweden version:SYH02-4D
DK version:SYH02-NN
German version:SYH02-D
French version:SYH02-F
U.K. version:SYH02-E

Approval:CE/GS/S/ROHS



SYH04-4D

4 WAY SOCKETS

Cable type:H07RN-F3G1.5/2.5mm²
H05RR-F3G1.5mm²

Sweden version:SYH04-4D
DK version:SYH04-NN
German version:SYH04-D
French version:SYH04-F
U.K. version:SYH04-E

Approval:CE/GS/S/ROHS



>> New Products



>> New Products



GJX01B-KM-D

NAME	POWER	POLES	WATERPROOF RATING
GJX01B-KM-D	16A 250V~	3P+N+E	IP44



GJX01B-33-D

NAME	POWER	POLES	WATERPROOF RATING
GJX01B-33-D	16A 250V~	3P+N+E	IP44



GJX01B-K3-F

NAME	POWER	POLES	WATERPROOF RATING
GJX01B-K3-F	16A 250V~	3P+N+E	IP44



GJX01C-55-E

NAME	POWER	POLES	WATERPROOF RATING
GJX01C-55-E	16A 250V~	2P+E	IP44

