



NINGBO APC ELECTRONICS CO.,LTD

STRUCTURED CABLING SOLUTION

已批准



Ningbo APC electronics co.,ltd

ADD:Room 803 Building B, Donghu Mansion No 101,Qianhu
North Road, Yinzhou district Ningbo City, Zhejiang China.

Contact: Tianli Zhang

TEL: 0086 574-88283679, 0086 574-88281359

M.T: 0086 18657456001 FAX: 0086 574-88283859

E-mail: sales@apc-elec.com SKYPE:shawnliapc

Website:www.apc-elec.com

NINGBO • CHINA



WELCOME TO APC NETWORK CABLING WORLD

COMPANY PROFILE

Ningbo APC Electronics Co.,Ltd is the subsidiary corporations which are the leading manufacturer of Cable and wires, network and communication equipment and accessories system in Ningbo China, which have two production base in Ningbo.

We have over 15 year experience in the development: Cable and network cabling products, Such as: Lan cable, coaxial cable, fiber optic cable, USB cable HDMI cable, Network cabinet, patch panel, keystone jack, cable tester,surface box and so on.

. The products have Various standard testing and certiciate :ISO, UL, CE, CE, etc. The factory covers 8000 m² and has more than 300 employees, highly skilled engineers, designers.As an OEM and ODM manufacturer. Our products mainly export to Europe, America, Middle east, Africa etc.

Highest quality products and sincere service are our purpose. Perfect design and resonable price are predominance. We Sincerely welcome you come to us, Don't Hesitate select us for business cooperation to create success together with us.



CONTENT



01-18 PATCH PANEL	19-20 WIRING BLOCK	21-24 CABLE MANAGEMENT	25-25 19" BRUSH PANEL	26-36 KEYSTONE JACK
37-39 SURFACE BOX	40-42 COUPLER AND CONNECTION BOX	43-44 ISDN	45-48 86 MODEL FACE PLATE	49-55 UK FACE PLATE
56-58 FRANCE FACE PLATE	59-59 GERMAN FACE PLATE	60-60 AUSTRALIA FACE PLATE	61-69 USA FACE PLATE	70-72 MODULAR PLUG
73-74 TELEPHONE ACCESSORIES	75-78 ADSL SPLITTER	79-86 CABLE TESTER	87-105 NETWORK TOOLS	106-116 TOOLS KITS
117-123 LSA MODULE	124-127 DISTRIBUTION BOX	128-130 BACK MOUNT FRAME	131-136 FIBER OPTIC PATCH PANEL AND TERMINATION BOX	137-138 FIBER OPTIC SPLICE CLOSURE



APC610001
19"1U FTP CAT.6A PATCH PANEL
Krone & 110 Dual IDC

STP CAT.6A 24-port shielded patch panel can be mounted in 19" racks or cabinets. Cat.6A marking, The panel has the pin connection scheme of T568B and T568A. Cable clamping clips and grounding provide shielding continuity. The cover which is fixed on the panel protects panel contacts from outer electromagnetic fields. There is an rear cable manager for cable fixation with ties.



Specifications	Meets ANSI/TIA/EIA- 568-B.2 Category 6 requirements Meets TIA/EIATSB-40 Meets ISO/IEC Generic Cabling Standard 11801:2002 ed.2.0 Meets CENELEC Generic Cabling Standard EN50173 - 1:2002
Description	19" standard size for mounting in racks and cabinets This patch panel is designed for 22-26 AWG solid conductors Height: 1U Vertical termination
Materials	Housing: 0.06" (1.6 mm) thick steel Cover: 0.039" (1 mm) thick steel PCB (printed circuit board): FR-4 0.06" (1.6 mm) thick, 2 /ayers Contacts: 0.018" (0.45 mm) phosphor bronze with 50 microinches (1.27 micron) gold plating on contact area IDC: PC UL94V-0
Construction characteristic features	Modern design and mounting simplicity Color marking of conductors according to T568B and T568A Numeral marking of ports on the front side of the panel Numeral marking of IDC modules on the rear side of the panel Space for additional marking
Electrical characteristics	According to UL 1863 Current rating: 1.5 A max Voltage rating: 150V Contact resistance: 20 m-ohm Insulation resistance: 500 M-ohm Dielectric withstand voltage: 1000 V AC RMS, 60Hz/1min



APC610002
19"1U UTP Cat.6A Patch Panel 24 Ports.
With back bar
Krone & 110 Dual IDC



APC610003
19"1U STP Cat.6A Blank Patch Panel 24 Ports
Use For STP Keystone jacks
With Back Bar



APC610004
19"1U UTP Cat.6A Blank Patch Panel 24 Ports
Use For UTP Keystone jacks
With Back Bar.



APC610005
19"1U STP Cat.6A Blank Patch Panel 16 Ports
Use For STP Keystone jacks
With Back Bar.



APC610006
19"1U STP Cat.6A Blank Patch Panel 24 Ports
Use For Keystone jacks
With Back Bar.



APC610007
19" 1U STP Cat.6A Blank Patch Panel 24 Ports
Use For Keystone jacks
With Back Bar.



APC610008
19" 1U STP Cat.6A Blank Patch Panel 24 Ports
Use For STP Keystone jacks
With Back Bar.



APC610009
19" 1U UTP Cat.6a Patch Panel 24 Ports
Toolless, With back bar.
APC610010
19" 1U UTP Cat.6 Patch Panel 24 Ports
Toolless, With back bar.



APC610011
19" 0.5U STP Cat.6A Blank Patch Panel 24 Ports
Use For STP Keystone jacks
With Back Bar.



APC610012
19" 0.5U UTP Cat6A Patch Panel 24 Ports
Krone&110 Daul IDC



APC610013
19" 0.5U UTP Cat6 Patch Panel 24 Ports
Krone&110 Daul IDC
APC610014
19" 0.5U UTP Cat5e Patch Panel 24 Ports
Krone&110 Daul IDC

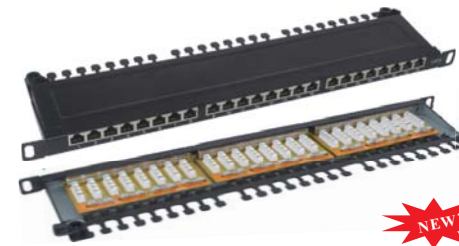

APC610015
19" 0.5U UTP Cat6A Patch Panel 24 Ports
Krone&110 Daul IDC
APC610016
19" 0.5U UTP Cat6 Patch Panel 24 Ports
Krone&110 Daul IDC
APC610017
19" 0.5U UTP Cat5e Patch Panel 24 Ports
Krone&110 Daul IDC



APC610018
19" 0.5U STP Cat6A Patch Panel 24 Ports
Krone&110 Daul IDC
APC610019
19" 0.5U STP Cat6 Patch Panel 24 Ports
Krone&110 Daul IDC
APC610020
19" 0.5U STP Cat5e Patch Panel 24 Ports
Krone&110 Daul IDC



APC610021
19" 1U STP Cat6A Patch Panel 48 Ports
Krone&110 Daul IDC
APC610022
19" 1U STP Cat6 Patch Panel 48 Ports
Krone&110 Daul IDC
APC610023
19" 1U STP Cat5e Patch Panel 48 Ports
Krone&110 Daul IDC



APC610024
2U Wall-Mounted UTP Cat.5e Patch Panel 12Ports
Krone&110 Daul IDC
APC610025
2U Wall-Mounted UTP Cat.6 Patch Panel 12Ports
Krone&110 Daul IDC



APC610026
10*1U UTP Cat5e Patch Panel 6 Ports
Krone&110 Dual IDC.
APC610027
10*1U UTP Cat6 Patch Panel 6 Ports
Krone&110 Dual IDC.



APC610036
WALL-MOUNTED UTP Cat5e Patch Panel 12 Ports
With 2xRJ21(50 PIN) connector



APC610037
Wall-mounted 45 Degree UTP Cat5e Patch Panel 12 Ports
Krone&110 Dual IDC.



APC610028
10*1U UTP Cat5e Patch Panel 8 Ports
Krone&110 Dual IDC.
APC610029
10*1U UTP Cat6 Patch Panel 8 Ports
Krone&110 Dual IDC.



APC610038
Wall-mounted 45 Degree UTP Cat6 Patch Panel 12 Ports
Krone&110 Dual IDC.



APC610030
10*1U UTP Cat5e Patch Panel 12 Ports
Krone&110 Dual IDC.
APC610031
10*1U UTP Cat6 Patch Panel 12 Ports
Krone&110 Dual IDC.



APC610039
19*1U UTP Cat5e Patch Panel 12 Ports
Krone&110 Dual IDC.
APC610040
19*1U UTP Cat6 Patch Panel 12 Ports
Krone&110 Dual IDC.



APC610032
Wall-Mounted UTP Cat5e Patch Panel 12 Ports
Krone&110 Dual IDC.
APC610033
Wall-Mounted UTP Cat6 Patch Panel 12 Ports
Krone&110 Dual IDC.



APC610041
19*1U UTP Cat5e Patch Panel 18 Ports
Krone&110 Dual IDC.
APC610042
19*1U UTP Cat6 Patch Panel 18 Ports
Krone&110 Dual IDC.



APC610034
Wall-Mounted UTP Cat5e Patch Panel 12 Ports
Krone&110 Dual IDC.
APC610035
Wall-Mounted UTP Cat6 Patch Panel 12 Ports
Krone&110 Dual IDC.



APC610043
19*1U UTP Cat5e Patch Panel 16 Ports
Krone&110 Dual IDC.



APC610044
19*1U UTP Cat5e Patch Panel 24 Ports
Krone&110 Dual IDC.
APC610045
19*1U UTP Cat6 Patch Panel 24 Ports
Krone&110 Dual IDC.



APC610046
19*1U UTP Cat5e Patch Panel 16 Ports
Krone&110 Dual IDC.
APC610047
19*1U UTP Cat6 Patch Panel 16 Ports
Krone&110 Dual IDC.



APC610048
19*1U UTP Cat5e Patch Panel 16 Ports
Krone&110 Dual IDC.
APC610049
19*1U UTP Cat6 Patch Panel 16 Ports
Krone&110 Dual IDC.



APC610050
19*2U UTP Cat5e Patch Panel 32 Ports
Krone&110 Dual IDC.



APC610051
19*1U UTP Cat5e Patch Panel 24 Ports
Without back bar, Krone&110 Dual IDC.
APC610052
19*1U UTP Cat5e Patch Panel 24 Ports
With back bar, Krone&110 Dual IDC.
APC610053
19*1U UTP Cat6 Patch Panel 24 Ports
Without back bar, Krone&110 Dual IDC.
APC610054
19*1U UTP Cat6 Patch Panel 24 Ports
With back bar, Krone&110 Dual IDC.

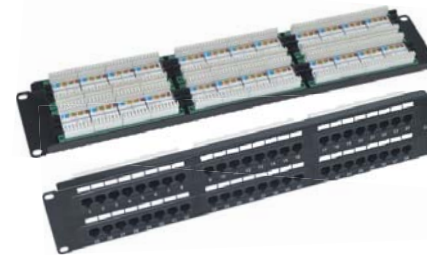

APC610055
19*2U UTP Cat5e Patch Panel 48 Ports
Without back bar, Krone&110 Dual IDC.



APC610056
19*2U UTP Cat5e Patch Panel 48 Ports
With back bar, Krone&110 Dual IDC.



APC610057
19*2U UTP Cat6 Patch Panel 48 Ports
Without back bar, Krone&110 Dual IDC.



APC610058
19*2U UTP Cat6 Patch Panel 48 Ports
With back bar, Krone&110 Dual IDC.



APC610059
19*1U UTP Cat5e Patch Panel 24 Ports
Krone&110 Dual IDC.



APC610060
19*1U UTP Cat6 Patch Panel 24 Ports
Krone&110 Dual IDC.



APC610061
19*2U UTP Cat5e Patch Panel 48 Ports
Krone&110 Dual IDC.



APC610062
19*2U UTP Cat6 Patch Panel 48 Ports
Krone&110 Dual IDC.



APC610063
19*4U UTP Cat5e Patch Panel 96 Ports
Krone&110 Dual IDC.



APC610064
19*4U UTP Cat6 Patch Panel 96 Ports
Krone&110 Dual IDC.



APC610065
19*1U UTP Cat5e Patch Panel 24 Ports
Krone&110 Dual IDC.



APC610066
19"1U 45 Degree UTP Cat5e Patch Panel 24 Ports
Krone&110 Dual IDC.
APC610067
19"1U 45 Degree UTP Cat6 Patch Panel 24 Ports
Krone&110 Dual IDC.



APC610075
19"2U UTP Cat5e Patch Panel 48 Ports
Krone&110 Dual IDC,
With or W/T back bar.
APC610076
19"2U UTP Cat6 Patch Panel 48 Ports
Krone&110 Dual IDC,
With or W/T back bar.



APC610068
10"1U UTP Cat5e Patch Panel 12 Ports
Krone&110 Dual IDC.
APC610069
10"1U UTP Cat6 Patch Panel 12 Ports
Krone&110 Dual IDC.



APC610077
5"1U UTP Cat5e Patch Panel 6 Ports.
110 Type IDC.



APC610070
19"1U UTP Cat5e Patch Panel 12 Ports
Krone&110 Dual IDC.
APC610071
19"1U UTP Cat6 Patch Panel 12 Ports
Krone&110 Dual IDC.



APC610078
10"1U UTP Cat5e Patch Panel 12 Ports
110 Type IDC.



APC610072
19"1U UTP Cat6 Patch Panel 18 Ports
Krone&110 Dual IDC.



APC610079
19"1U UTP Cat5e Patch Panel 12 Ports
110 Type IDC.



APC610073
19"1U UTP Cat5e Patch Panel 24 Ports
Krone&110 Dual IDC,
With or W/T back bar.
APC610074
19"1U UTP Cat6 Patch Panel 24 Ports
Krone&110 Dual IDC,
With or W/T back bar.



APC610080
19"1U UTP Cat5e Patch Panel 24 Ports
110 Type IDC.



APC610081
19"2U UTP Cat5e Patch Panel 48 Ports
110 Type IDC.



APC610088
19"1U Telephone Panel 50 Ports 8P4C
Krone&110 Dual IDC



APC610082
19"1U UTP Cat5e Patch Panel 24 Ports
Dual IDC, With Led
APC610083
19"1U UTP Cat6 Patch Panel 24 Ports
Dual IDC, With Led



APC610089
19"1U Telephone Panel 50 Ports
8P6C(contact:5/4/3/6/1/2),Krone&110 Dual IDC
APC610090
19"1U Telephone Panel 50 Ports
8P4C(contact:5/4/3/6),Krone&110 Dual IDC
APC610091
19"1U Telephone Panel 50 Ports
8P6C(contact:5/4/3/6/7/8),Krone&110 Dual IDC



APC610084
19"1U Telephone Panel 25 Ports 8P4C(5/4/3/6)
Krone&110 Dual IDC
APC610085
19"1U Telephone Panel 25 Ports 8P6C(5/4/1/2/3/6)
Krone&110 Dual IDC



APC610092
19"1U Telephone Panel 56 Ports 8P4C
Krone&110 Dual IDC.
APC610093
19"1U Telephone Panel 56 Ports 8P6C
Krone&110 Dual IDC.



APC610086
19"1U Telephone Panel 25 Ports 8P4C(5/4/3/6)
Krone&110 Dual IDC



APC610094
19"1U Telephone Panel 60 Ports 8P4C
Krone&110 Dual IDC.



APC610087
19"1U Telephone Panel 32 Ports 8P4C
Krone&110 Dual IDC



APC610095
19"1U Telephone Panel 25 Ports 8P4C
Krone&110 Dual IDC.



APC610096
19*1U Telephone Patch Panel 50 Ports 8P4C.
Krone&110 Dual IDC.



APC610097
19*1U Telephone Patch Panel 25 Ports 6p4c.
With 25pcs RJ11 KEYSTONE JACK.
110 IDC.



APC610098
19*2U Telephone Patch Panel 50 Ports 6p4c.
With 50pcs RJ11 KEYSTONE JACK.
110 IDC.



APC610099
19*1U UTP Blank Patch Panel 12 Ports
Use for UTP Keystone Jacks.

APC610100
19*1U UTP Blank Patch Panel 16 Ports
Use for UTP Keystone Jacks.

APC610101
19*1U UTP Blank Patch Panel 18 Ports
Use for UTP Keystone Jacks.



APC610102
19*2U UTP Blank Patch Panel 24 Ports
Use for UTP Keystone Jacks.

APC610103
19*2U UTP Blank Patch Panel 32 Ports
Use for UTP Keystone Jacks.



APC6101004
19*1U UTP Blank Patch Panel 12 Ports
Use for UTP Keystone Jacks.

APC6101005
19*1U UTP Blank Patch Panel 16 Ports
Use for UTP Keystone Jacks.

APC6101006
19*1U UTP Blank Patch Panel 18 Ports
Use for UTP Keystone Jacks.



APC6101007
19*2U UTP Blank Patch Panel 24 Ports
Use for UTP Keystone Jacks.

APC6101008
19*3U UTP Blank Patch Panel 48 Ports
Use for UTP Keystone Jacks.

APC6101009
19*2U UTP Blank Patch Panel 48 Ports
Use for UTP Keystone Jacks.



APC610110
10*1U UTP Cat5e Blank Patch Panel 12 Ports
Use for Keystone Jacks.

APC610111
10*1U UTP Cat6 Blank Patch Panel 12 Ports
Use for Keystone Jacks.



APC610112
19*1U UTP Cat5e Blank Patch Panel 24 Ports
Use for UTP Keystone Jacks.

APC610113
19*1U UTP Cat6 Blank Patch Panel 24 Ports
Use for UTP Keystone Jacks.



APC610114
19*1U STP Cat5e Blank Patch Panel 24 Ports
Use for STP Keystone Jacks.

APC610115
19*1U STP Cat6 Blank Patch Panel 24 Ports
Use for STP Keystone Jacks.



APC610116
19" 1U UTP Cat5e Blank Patch Panel 24 Ports
Use For UTP Keystone Jacks.
With Back Bar.

APC610117
19" 1U UTP Cat6 Blank Patch Panel 24 Ports
Use For UTP Keystone Jacks.
With Back Bar.



APC610124
19" 2U STP Blank Patch Panel 48 Ports
Without Jacks.
Use For 3M Keystone Jacks



APC610118
19" 2U UTP Blank Patch Panel 48 Ports
A:Without Back Bar.
B:With Back Bar.



APC610125
10" 1U STP Cat5e Patch Panel 8 Ports
Krone&110 Dual IDC.

APC610126
10" 1U STP Cat6 Patch Panel 8 Ports
Krone&110 Dual IDC.



APC610119
19" 1U UTP Cat5e Blank Patch Panel 24 Ports
Use For UTP Keystone Jacks
With Back Bar.

APC610120
19" 1U UTP Cat6 Blank Patch Panel 24 Ports
Use For UTP Keystone Jacks
With Back Bar.



APC610127
10" 1U STP Cat5e Patch Panel 8 Ports
Krone&110 Dual IDC.

APC610128
10" 1U STP Cat6 Patch Panel 8 Ports
Krone&110 Dual IDC.



APC610121
19" 1U UTP Cat5e Blank Patch Panel 24 Ports
Use For UTP Keystone Jacks
With Back Bar.

APC610122
19" 1U UTP Cat6 Blank Patch Panel 24 Ports
Use For UTP Keystone Jacks
With Back Bar.

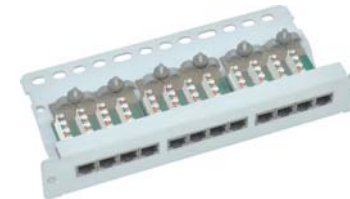

APC610129
10" 1U STP Cat5e Patch Panel 12 Ports
Krone&110 Dual IDC.



APC610123
19" 1U STP Blank Patch Panel 24 Ports
Without Jacks
Use For 3M Keystone Jacks



APC610130
10" 1U STP Cat5e Patch Panel 12 Ports
Krone&110 Dual IDC.

APC610131
10" 1U STP Cat6 Patch Panel 12 Ports
Krone&110 Dual IDC.



APC610132
10*1U STP Cat5e Patch Panel 12 Ports
Krone&110 Dual IDC.
APC610133
10*1U STP Cat6 Patch Panel 12 Ports
Krone&110 Dual IDC.



APC610142
19*1U STP Cat5e Patch Panel 24 Ports
Krone&110 Dual IDC.



APC610134
19*1U STP Cat5e Patch Panel 16 Ports
Krone&110 Dual IDC.
APC610135
19*1U STP Cat6 Patch Panel 16 Ports
Krone&110 Dual IDC.



APC610143
19*1U F Connector Patch Panel
With 16 Pcs F Connector Female-Female
APC610144
19*1U F Connector Patch Panel
With 24 Pcs F Connector Female-Female



APC610136
19*1U UTP Cat5e Patch Panel 24 Ports
Krone&110 Dual IDC.
APC610137
19*1U UTP Cat6 Patch Panel 24 Ports
Krone&110 Dual IDC.



APC610145
19*1U BNC Connector Patch Panel
With 12 Pcs BNC Connector, Female-Female
APC610146
19*1U BNC Connector Patch Panel
With 16 Pcs BNC Connector, Female-Female
APC610147
19*1U BNC Connector Patch Panel
With 24 Pcs BNC Connector, Female-Female



APC610138
19*1U UTP Cat5e Patch Panel 48 Ports
Krone&110 Dual IDC.
APC610139
19*1U UTP Cat6 Patch Panel 48 Ports
Krone&110 Dual IDC.



APC610148
19*2U BNC Connector Patch Panel
With 32 Pcs BNC Connector, Female-Female



APC610140
19*1U STP Cat5e Patch Panel 24 Ports
Krone&110 Dual IDC.
APC610141
19*1U STP Cat6 Patch Panel 24 Ports
Krone&110 Dual IDC.



APC610149
19*2U UTP Cat5e Patch Panel 24 Ports
110 Type.
APC610150
19*2U UTP Cat6 Patch Panel 24 Ports
110 Type.



APC610151
110 Wiring Block Without Legs
50 Pairs



APC610152
110 Wiring Block Without Legs
100 Pairs



APC610153
110 Wiring Block With Legs
50 Pairs



APC610154
110 Wiring Block With Legs
100 Pairs



APC610155
110 Wiring Block Without Legs
25 Pairs



APC610156
110 Wiring Block Without Legs
16 Pairs



APC610157
110 Wiring Block Without Legs
12 Pairs

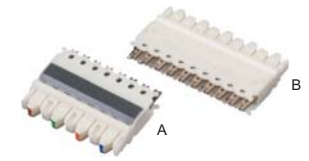

APC610158
110 IDC Connector
A: 4 Pairs
B: 5 Pairs



APC610159
19" 1U 110 Wiring Panel, 100Pairs
A: Without 4&5Pairs 110 IDC
B: With 4&5Pairs 110 IDC



APC610160
19" 2U 110 Wiring Panel, 200Pairs
A: Without 4&5Pairs 110 IDC
B: With 4&5Pairs 110 IDC

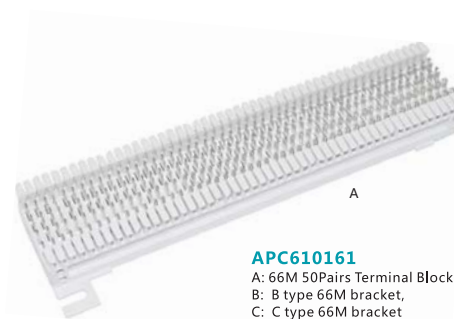

APC610161
A: 66M 50Pairs Terminal Block
B: B type 66M bracket,
C: C type 66M bracket

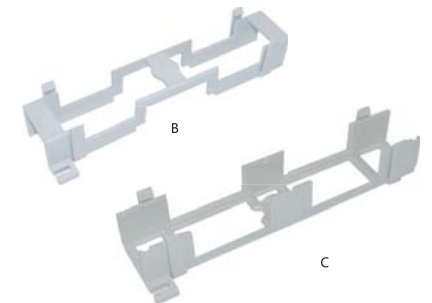



APC611001
19" 1U Cable Management
With 5 Plastic Rings



APC611002
19" 2U Cable Management
With 10 Plastic Rings



APC611011
19" 1U Cable Management
With 5 Plastic Rings



APC611012
19" 1U Cable Management
With 5 Pcs Metal Rings



APC611003
19" 1U Cable Management
With 5 Plastic Rings



APC611004
1U 19" Cable Management
With 4 Pcs Plastic Rings



APC611013
19" 1U cable management bar
with 5 metal rings, Rings height: 65MM
APC611014
19" 1U cable management bar
with 5 metal rings, Rings height: 90MM



APC611015
19" 2U Cable Management
With 5 Metal Rings
Ring Height:65mm



Cable Management
APC611005
19" 1U With 5 Pcs Plastic Rings
APC611006
19" 2U With 10 Pcs Plastic Rings



APC611007
19" 1U Cable Management
With 5 Plastic Rings



APC611016
19" 1U Cable Management
With 5 Pcs Metal Rings
Ring Height:68mm



APC611017
19" 1U Cable Management
With 4 Pcs Metal Rings
Ring Height:65mm



APC611008
19" 2U Cable Management
With 10 Plastic Rings



Cable Management
APC611009
19" 1U With 4 Pcs Plastic Rings
APC611010
19" 2U With 8 Pcs Plastic Rings



APC611018
19" 2U Cable Management
With 4 Metal Rings
Ring Height:65mm



APC611019
19" 1U Cable Management
Metal Cover



APC611020
19" 1U Cable Management
Metal Cover



APC611021
19" 2U Cable Management
Metal Cover



APC611028
19" 1U Cable Management
Plastic Material Double side



APC611029
19" 1U Cable Management
Plastic Material



APC611022
19" 1U Cable Management
Metal Cover
Ring Height: 44mm



APC611023
19" 2U Cable Management
Metal Cover
Ring Height: 44mm



APC611030
19" 1U Cable Management
Plastic Material



APC611031 19" 1U Blank Panel
APC611032 19" 2U Blank Panel



APC611024
19" 1U Cable Management
Steel Bar, Plastic Rings and cover



APC611025
19" 1U Cable Management
Steel Bar, Plastic Rings and cover
Double side



APC611033
19" 1U Cable Management



APC611034
19" 1U 110 Cable Management



APC611026
19" 1U Cable Management
Plastic Material



APC611027
19" 2U Cable Management
Plastic Material

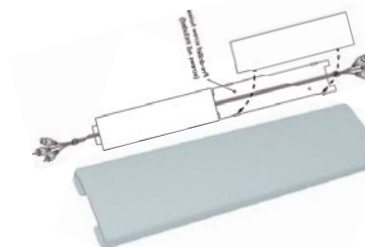

APC611035
Cable concealer
hide protect and manage cables



APC611036
110 Cable Management

BRUSH PANEL

[Http://www.apc-elec.com](http://www.apc-elec.com)



APC611037
10" 1U Cable Management
Brush Type



APC611038
19" 1U Cable Management
Brush Type



APC611039
19" 1U Cable Management
Brush Type



APC611040
19" 1U Cable Management
Brush Type



APC611041
19" 1U Cable Management
With 4 Pcs Metal Rings & Brush



APC611042
19" 1U Cable Management
With 5 Pcs Metal Rings & Brush



APC611043
19" 1U Cable Management
With 5 Pcs Plastic Rings & Brush



APC611044
19" 1U Cable Management
Brush Type



APC620001
STP Cat6a Keystone Jack
Toolless Type, 180Degree



APC620002
UTP Cat6a Keystone Jack
Toolless Type, 180Degree



APC620003
STP Cat6a Keystone Jack
Toolless Type, 180Degree



APC620004
UTP Cat6a Keystone Jack
Toolless Type, 180Degree



APC620005
UTP Cat6a Keystone Jack
Dual IDC Type, 180Degree



APC620006
UTP Cat6a Keystone Jack
Toolless Type, 180Degree



APC620007
UTP Cat.6a Keystone Jack
In-line coupler, RJ45-RJ45



APC620008
STP Cat.6a Keystone Jack
In-line coupler, RJ45-RJ45



APC620009
UTP Cat.6a Keystone Jack
Dual IDC Type, 180 Degree



APC620010
UTP Cat.6a Keystone Jack
Dual IDC Type, 180 Degree



APC620011
UTP Cat.6a Keystone Jack
Dual IDC Type, 180 Degree



APC620012
UTP Cat6a Keystone Jack
Toolless Type

KEYSTONE JACK



APC620013
STP Cat6 Keystone Jack
Toolless Type, 180 Degree



APC620015
UTP Cat6 Keystone Jack
Toolless Type, 180 Degree



APC620017
STP Cat6 Keystone Jack
Toolless Type, 180 Degree

APC620014
STP Cat5e Keystone Jack
Toolless Type, 180 Degree

APC620016
UTP Cat5e Keystone Jack
Toolless Type, 180 Degree

APC620018
STP Cat5e Keystone Jack
Toolless Type, 180 Degree



APC620028
UTP Cat6 Keystone Jack
Toolless Type



APC620029
UTP Cat.6 Keystone Jack
Dual IDC Type,90 Degree



APC620031
UTP Cat.6 Keystone Jack
110 IDC Type,90 Degree



APC620019
UTP Cat6 Keystone Jack
Toolless Type, 180 Degree



APC620020
UTP Cat.6 Keystone Jack
110 IDC type,90 Degree



APC620021
UTP Cat.6 Keystone Jack
110 IDC type,180 Degree



APC620033
UTP Cat.6 Keystone Jack
Dual IDC Type,180 Degree.



APC620035
UTP Cat.6 Keystone Jack
Dual IDC Type,180 Degree
With Dust Cover.



APC620037
UTP Cat.6 Keystone Jack
Dual type,180 Degree



APC620022
UTP Cat.6 Keystone Jack
110 IDC Type,90 Degree



APC620023
UTP Cat.6 Keystone Jack
110 IDC type,90 Degree



APC620024
UTP Cat.6 Keystone Jack
Dual IDC type,180 Degree



APC620025
UTP Cat.6 Keystone Jack
Toolless type,180 Degree



APC620026
UTP Cat.6 Keystone Jack
Toolless type,90 Degree



APC620027
UTP Cat.6 Keystone Jack
Dual IDC Type,180 Degree



APC620039
UTP Cat.6 Keystone Jack
Dual type,180 Degree
With Dust Cover



APC620041
UTP Cat.6 Keystone Jack
With Dust Cover
Dual IDC type,180 Degree



APC620042
UTP Cat.6 Keystone Jack
Dual IDC type,90 Degree



APC620044
UTP Cat.6 Keystone Jack
Dual IDC Type,180 Degree.
APC620045
UTP Cat.5e Keystone Jack
Dual IDC Type,180 Degree.



APC620046
UTP Cat.6 Keystone Jack
Toolless type,90 Degree
APC620047
UTP Cat.5e Keystone Jack
Toolless type,90 Degree



APC620048
UTP Cat.6 Coupler RJ45-RJ45
APC620049
UTP Cat.5e Coupler RJ45-RJ45



APC620061
UTP Cat.6 Keystone Jack
110 IDC type,90 Degree
APC620062
UTP Cat.5e Keystone Jack
110 IDC type,90 Degree



APC620063
UTP Cat.6 Keystone Jack
Dual type,90 Degree
APC620064
UTP Cat.5e Keystone Jack
Dual type,90 Degree



APC620065
UTP Cat.6 Keystone Jack
Toolless type,180 Degree
APC620066
UTP Cat.5e Keystone Jack
Toolless type,180 Degree



APC620050
UTP Cat.6 Coupler RJ45-RJ45



APC620051
UTP Cat.6 Keystone Jack
Toolless type,90 Degree
APC620052
UTP Cat.5e Keystone Jack
Toolless type,90 Degree



APC620053
UTP Cat.6 Keystone Jack
Dual type,90 Degree
APC620054
UTP Cat.5e Keystone Jack
Dual type,90 Degree



APC620067
UTP Cat.6 Keystone Jack
Toolless Type, 180 Degree
APC620068
UTP Cat.5e Keystone Jack
Toolless Type, 180 Degree



APC620069
UTP Cat.6 Keystone Jack
Toolless type,90 Degree
APC620070
UTP Cat.5e Keystone Jack
Toolless type,90 Degree



APC620071
STP Cat.6 Keystone Jack
110 IDC Type, 90 Degree
APC620072
STP Cat.5e Keystone Jack
110 IDC Type, 90 Degree



APC620055
UTP Cat.6 Keystone Jack
Toolless type,180 Degree
APC620056
UTP Cat.5e Keystone Jack
Toolless type,180 Degree



APC620057
UTP Cat.6 Keystone Jack
110 IDC Type,90 Degree.
APC620058
UTP Cat.5e Keystone Jack
110 IDC Type,90 Degree.



APC620059
UTP Cat.6 Keystone Jack
110 type,90 Degree
APC620060
UTP Cat.5e Keystone Jack
110 type,90 Degree



APC620073
STP Cat.6 Keystone Jack
Dual IDC Type, 180 Degree
APC620074
STP Cat.5e Keystone Jack
Dual IDC Type, 180 Degree



APC620075
STP Cat.6 Keystone Jack
Dual IDC Type, 180 Degree
APC620076
STP Cat.5e Keystone Jack
Dual IDC Type, 180 Degree



APC620077
STP Cat.6 coupler,RJ45-RJ45
APC620078
STP Cat.5e coupler,RJ45-RJ45



APC620079
STP Cat.6 coupler,RJ45- RJ45
APC620080
STP Cat.5e coupler,RJ45- RJ45



APC620081
STP Cat.5e coupler,RJ45- RJ45



APC620082
STP Cat.6 Keystone Jack
Toolless Type, 180 Degree
APC620083
STP Cat.5e Keystone Jack
Toolless Type, 180 Degree



APC620093
UTP Cat.5e Keystone Jack
Toolless type,90 Degree



APC620094
UTP Cat.5e Keystone Jack
Toolless type,90 Degree



APC620095
UTP Cat.5e Keystone Jack
Toolless type,180 Degree



APC620084
UTP Cat.5E Keystone Jack
Dual IDC Type,180 Degree



APC620085
UTP Cat5e Keystone Jack
Krone IDC Type, 90 Degree.



APC620086
UTP Cat5e Keystone Jack
110 IDC Type,90 Degree.



APC620096
UTP Cat.5e keystone jack
Toolless type,90 Degree



APC620097
STP Cat.5e Keystone Jack
Half-Shielded
110 IDC Type, 180 Degree



APC620098
UTP Cat.5e Keystone Jack
Toolless type,90 Degree,



APC620087
UTP Cat.5e Keystone Jack
110 IDC Type,90 Degree



APC620088
UTP Cat.5e Keystone Jack
110 IDC Type,90 Degree



APC620089
UTP Cat.5e Keystone Jack
110 IDC Type,90 Degree



APC620099
UTP Cat.5e Keystone Jack
Toolless type,90 Degree



APC620100
UTP Cat.5e Keystone Jack
Toolless type,90 Degree



APC620101
UTP Cat.5e Keystone Jack
110 IDC type,90 Degree



APC620090
UTP Cat.5e keystone Jack
In-line Coupler RJ45- RJ45



APC620091
UTP Cat.5e Keystone Jack
Toolless type,90 Degree



APC620092
UTP Cat.5e Keystone Jack
Toolless type,90 Degree



APC620102
Cat3 Keystone Jack
6P4C,110 IDC Type.



APC620103
Cat3 Keystone Jack
6P4C,110 IDC Type.



APC620104
Cat3 Keystone Jack
6P4C,Screw Type.



APC620105
Cat3 Keystone Jack
P4C,110 IDC Type.



APC620106
Cat3 Keystone Jack
6P4C,110 IDC Type.



APC620107
CAT3 Keystone Jack
6P4C or 6P6C,Dual IDC



APC620117
Cat3 Keystone Jack
6P6C,110 IDC Type.



APC620118
Cat3 Keystone Jack
6P4C or 6P6C,Dual IDC Type.



APC620119
Cat.3 Keystone Jack
6p6c, Toolless Type;



APC620108
Cat.3 Keystone Jack
6p4c or 6p6c, Toolless Type;



APC620109
Cat.3 Keystone Jack
6p4c or 6p6c, Toolless Type;



APC620110
Cat.3 Keystone Jack
6p4c or 6p6c, Toolless Type;



APC620120
Cat3 Keystone Jack
6P4C,110 IDC Type.



APC620121
HDMI Keystone Jack
A:With "HDMI" Printing
B:W/O "HDMI" Printing



APC620122
USB Keystone Jack
USB 2.0 A Female to A Female
A: Horizontal, B: Vertical



APC620111
Cat.3 Keystone Jack
6p4c or 6p6c, Toolless Type;



APC620112
Cat3 Keystone Jack
6P6C,110 IDC Type.



APC620113
Cat3 Keystone Jack
6P4C,110 IDC Type.



APC620123
USB Keystone Jack
USB 2.0 B Female to B Female



APC620124
USB Keystone Jack
USB 2.0 A Female to B Female



APC620125
USB Keystone Jack
USB 2.0 B Female to A Female



APC620114
Cat3 Keystone Jack
Snap-In type;In-line coupler



APC620115
Cat3 Keystone Jack
6P4C,Screw Type.



APC620116
Cat3 Keystone Jack
6P4C,Screw Type.



APC620126
USB 3.0 A Female to A Female



APC620127
USB 3.0 A Female to A Female
90 Degree



APC620128
Fiber Optic SC adapter keystone Jack



APC620129
Coaxial TV Keystone Jack



APC620130
Coaxial TV Keystone Jack



AP01
Blank Insert For Wall Plate
AP02
Blank Insert for F type connector



APC620139
Keystone Jack-Modular RCA
Female To Female.(Gold Plated)



APC620140
Keystone Jack-3.5mm stereo
Female to Female



APC620141
Blank Keystone Jack
Australia Type.



APC620133
Blank Insert for BNC type connector



APC620134
Keystone Jack-Modular
F Type(Gold Plated)



APC620135
Keystone Jack - Modular RCA
A : Yellow Center, B : Blue Center
C : Red Center, D : White Center
E : Green Center



APC620142
Blank Keystone Jack
Australia Type.



APC620143
F Keystone Jack
Australia Type.



APC620144
BNC To F-81 Keystone Jac
Australia Type.

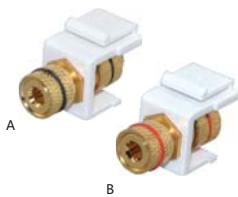

APC620136
Keystone Jack-Banana Jack
A: Black Ring
B: Red Ring.



APC620137
Keystone Jack-3.5mm stereo
Female to Female



APC620138
Keystone Jack-Modular BNC
Female To Female.



APC620145
HDMI Keystone Jack
Length=15cm
Australia Type.

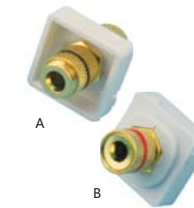

APC620146
Banana Keystone Jack
Australia Type
A: Black Ring,
B: Red Ring.



APC620147
3.5mm Keystone Jack
Australia Type.



APC630001
Surface Box 1 Port
A:With 1pcs Cat5e & 6 jack
B:Without Keystone jack



APC630002
Surface Box 2 Port
A:With 2pcs Cat5e & 6 jack
B:Without Keystone jack



APC630009
Surface Box 1 Port
A:With 1pcs
B:Without Keystone jack



APC630010
Surface Box 2 Port
A:With 2pcs
B:Without Keystone jack



APC630003
Surface Box 1 Port
A:With 1pcs
B:Without Keystone jack



APC630004
Surface Box 2 Port
A:With 2pcs
B:Without Keystone jack



APC630011
Surface Box 1 Port
UTP Cat.5e PCB Jack



APC630012
Surface Box 2 Port
UTP Cat.5e PCB Jack



APC630005
Surface Box 4 Port
A:With 4pcs
B:Without Keystone jack



APC630006
Surface Box 6 Port
A:With 6pcs
B:Without Keystone jack



APC630013
Surface Box 2 Port
UTP Cat.5e RJ45+RJ11 PCB Jack



APC630014
Surface Box 2 Port
UTP Cat.5E PCB Jack ,



APC630007
Surface Box 4 Port,
A:With 4pcs
B:Without Keystone jack



APC630008
Surface Box 6 Port
A:With 6pcs
B:Without Keystone jack



APC630015
Surface Box 1 Port
STP Cat.5e PCB Jack



APC630016
Surface Box 2 Port
STP Cat.5e PCB Jack



APC630017
Surface Box 2 Port
UTP Cat.5e PCB Jack
45 Degree.



APC630018
Telephone surface box 1 box
Telephone
RJ11 Jack, Tolless type.
Filled with gel



SURFACE BOX 1 PORT
APC630025 UTP Cat.5e PCB Jack
APC630026 UTP Cat.6 PCB Jack
APC630027 UTP Cat.6A PCB Jack



SURFACE BOX 1 PORT
APC630028 STP Cat.5e PCB Jack
APC630029 STP Cat.6 PCB Jack
APC630030 STP Cat.6A PCB Jack



APC630019
Surface Box 1 Port
UTP Cat.6 PCB Jack



APC630020
Surface Box 2 Port
UTP Cat.6 PCB Jack



SURFACE BOX 2 PORT
APC630031 UTP Cat.5e PCB Jack
APC630032 UTP Cat.6 PCB Jack
APC630033 UTP Cat.6A PCB Jack



SURFACE BOX 2 PORT
APC630034 STP Cat.5e PCB Jack
APC630035 STP Cat.6 PCB Jack
APC630036 STP Cat.6A PCB Jack



APC630021
Surface Box 1 Port
UTP Cat.6 PCB Jack



APC630022
Surface Box 2 Port
STP Cat.6 PCB Jack



APC630037
In-line Coupler
Cat.5e RJ45-RJ45
Un-shielded Type.



APC630038
In-line Coupler
Cat.6 RJ45-RJ45
Un-shielded Type.



APC630039
In-line Coupler
Cat.5e RJ45-RJ45
Un-shielded Type.



APC630023
Surface Box 1 Port
UTP Cat.6A PCB Jack



APC630024
Surface Box 2 Port
UTP Cat.6A PCB Jack



APC630040
In-line Coupler
1,2&3,6 Cross Over,
Un-shielded Type.



APC630041
In-line Coupler
Cat.5e RJ45-RJ45
Shielded Type.



APC630042
In-line Coupler
1,2&3,6 Cross Over
Shielded Type.



APC630043
In-line Coupler
Cat.6 RJ45-RJ45,
Shielded Type.



APC630044
In-line Coupler
UTP Cat.6 RJ45-RJ45



APC630045
In-line Coupler
UTP Cat.5E RJ45-RJ45



APC630052
Cat.6 Connection Box
Un-shielded type
Krone IDC block.



APC630053
Cat.5e Connection Box
Shielded type;
Krone IDC block



APC630054
Cat.6 Connection Box
shielded type
Krone IDC block.



APC630046
In-line Coupler
1,2 & 3,6 Cross Over



APC630047
In-line Coupler,
Cat.5e Shielded Type.



APC630048
In-line Coupler
Cat.5E RJ45-RJ45
Shielded Type.



APC630055
Cat.6 Connection Box
Un-shielded type
Krone IDC block



APC630056
Cat.6 Connection Box
shielded type
Krone IDC block



APC630057
Cat.6 Connection Box
Half-shielded
Krone IDC block



APC630049
1/2 Female Adapter
Cat.5e RJ45-2RJ45 adaptor
Shielded Type.



APC630050
Connection Box
Direct connection with screw
Size: 60x36x27mm



APC630051
Cat.5e connection box
Un-shielded type,
Krone IDC block,



APC630058
Cat.6 Connection Box
shielded type
Krone IDC block



APC630059
Cat.5e connection box
Un-shielded type

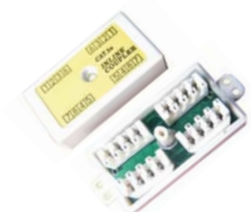

APC630060
Cat.6 connection box
Un-shielded type,

APC630061
Cat.5e connection box
Un-shielded type
APC630062
Cat.6 connection box
Un-shielded type



APC630063
UTP Cat5e Adapter
RJ45 Male to Female



APC630064
ISDN 1 Port adapter
A:shielded type;
B:Un-shielded type



APC630065
ISDN 2 Ports Adapter
A:shielded type;
B:Un-shielded type



APC630070
ISDN 2 ports adapter
Shielded type



APC630071
ISDN 4 ports Adapter
A:shielded type
B:Un-shielded type



APC630066
ISDN 2 Ports Adapter
Un-shielded type



APC630067
ISDN 2 ports Adapter
Shielded type



APC630072
ISDN 4 Portadapter
A:shielded type;
B:Un-shielded type



APC630073
ISDN 5 ports Adapter
A:shielded type;
B: Un-shielded type



APC630068
ISDN 2 Ports Adapter
Un-shielded type



APC630069
ISDN 2 ports adapter
Half-Shielded type



APC630074
ISDN 5 Portadapter
A:shielded type;
B:Un-shielded type



APC630075
ISDN 8 ports adapter
A:shielded type;
B: Un-shielded type



APC630076
Face Plate 1 Port
Size:86X86mm



APC630077
Face Plate 2 Port
Size:86X86mm



APC630078
Face Plate 3 Port
Size:86X86mm



APC630085
Face Plate 2 Port,
Size:86X86mm



APC630086
Face Plate 1 Port,
Size:86X86mm



APC630087
Face Plate 2 Port,
Size:86X86mm



APC630079
Face Plate 4 Port
Size:86X86mm



APC630080
Face Plate 1 Port
Size:86X86mm



APC630081
Face Plate 2 Port
Size:86X86mm



APC630088
Face Plate 1 Port,
Size:86X86mm



APC630089
Face Plate 2 Port,
Size:86X86mm



APC630090
Face Plate 1 Port, 45 Degree
Size:86X86mm



APC630082
Face Plate 1 Port
Size:86X86mm



APC630083
Face Plate 2 Port
Size:86X86mm



APC630084
Face Plate 1 Port,
Size:86X86mm



APC630091
Face Plate 2 Port, 45 Degree
Size:86X86mm



APC630092
Face Plate 1 Port,
Size:86X86mm



APC630093
Face Plate 2 Ports,
Size:86X86mm



APC630094
Face Plate 2 Ports,
45 Degree
Size:86X86mm



APC630095
Face Plate 1 Port,
Size:86X86mm



APC630096
Face Plate 2 Ports,
Size:86X86mm



APC630103
Face Plate 2 Port,
Size:86X86mm



APC630104
Face Plate 3 Port,
Size:86X86mm



APC630105
Face Plate 4 Port,
Size:86X86mm



APC630097
Face Plate 1 Port,
Size:86X86mm



APC630098
Face Plate 2 Ports,
Size:86X86mm



APC630099
Face plate, 2Ports
Use for Keystone jacks.
Size:86X86mm



APC630106
Fiber Face Plate,
1*SC Adapter
Size:86x86mm



APC630107
Fiber Face Plate,
For SC Fiber 2 ports
Size:86x86mm



APC630108
Fiber Face Plate,
For 2pcs ST Adapter,
Size:86x86mm



APC630100
Face Plate 1 Port,
Size:86X86mm



APC630101
Face Plate 2 Ports,
Size:86X86mm



APC630102
Face Plate 1 Port,
Size:86X86mm



APC630109
Fiber Optic Mount Box
For 2pcs SC or LC Adapter



APC630110
Telephone Face Plate
Size:86X86mm



APC630111
Telephone Face Plate
Size:86X86mm



APC630112
Back Box
Size:86X86X36mm

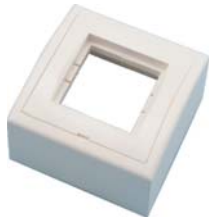

APC630113
LANmark EU style surface mount box
• For all 45 x 45 modules
• Easy to install
• 40mm usable depth



APC630114
45X45 modules face plate
LANmark EU Type.

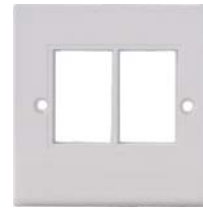

APC630121
Face Plate, Dual Port,
UK Type, Size:86x86mm



APC630122
Face plate UK type, 1Port
Use for Keystone jacks.
Size:86X86mm



APC630123
Face plate UK type, 2Port
Use for Keystone jacks.
Size:86X86mm



APC630115
Face Plate 1 Port,
UK type, Size:86X86mm



APC630116
Face Plate 2 Port,
UK type, Size:86X86mm



APC630117
Face Plate 2 Port,
UK type, Size:86X86mm



APC630124
UK Face plate, 45 Degree 1Port
Use for Keystone jacks.
Size:86X86mm



APC630125
UK Face plate, 45 Degree 2Port
Use for Keystone jacks.
Size:86X86mm



APC630126
UK Face plate, 45 Degree 1Port
Use for Keystone jacks.
Size:86X86mm



APC630118
Face Plate 4 Port,
UK type, Size:86X146mm

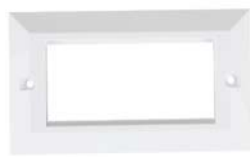

APC630119
Face Plate 4 Port,
UK type, Size:86X146mm



APC630120
Face Plate, Single Port,
UK Type, Size:86x86mm



APC630127
UK Face plate, 45 Degree 2Port
Use for Keystone jacks.
Size:86X86mm



APC630128
Telephone Face plate
1 Port, 6P6C, UK Socket,
Size:86X86mm



APC630129
Telephone Face plate
2 Port, 6P6C, UK Socket,
Size:86X86mm



APC630130
Telephone Face Plate,
UK Type,45 Degree
Size:86x86mm



APC630131
Blank Face Plate
Size:12.5X50mm



APC630132
Blank Face Plate
Size:25X50mm



APC630139
Cat.5e Keystone Jack,UK Type
Size:25X50MM



APC630140
Cat.6 Keystone Jack,UK Type
Size:25X50MM



APC630141
Cat5e Keystone Jack,UK Type,
Size:25X50 mm



APC630133
Blank Face Plate
Size:25X38mm



APC630134
UTP Cat.5e Module,UK type
Krone IDC Termination,
90 Degree. Size:25X50mm



APC630135
UTP Cat.6 Module, UK type
Krone IDC Termination,
90 Degree. Size:25X50mm



APC630142
Cat5e Keystone Jack,UK Type,
Size:25X50mm



APC630143
Cat5e/6 Stanard RJ45(6C) Modules
UK Type,Size:25X38mm



APC630144
Face Plate,UK Type.
Size:25X50mm, 45Degree



APC630136
Face plate UK type,
Use for Keystone jacks.
Size:25X50mm



APC630137
Cat5e Keystone Jack,UK Type
Size:25X38MM



APC630138
Cat6 Keystone Jack,UK Type
Size:25X38MM



APC630145
Face Plate,Single Port,
UK Type,Size:25x50mm



APC630146
Face plate,Single Port,
UK type, 45Degree,
Size:25X50mm



APC630147
Face plate,Single Port,
UK type, 45Degree,
Size:25X50mm



APC630148
Face plate, Single Port,
UK type, Size: 25X50mm



APC630149
Face plate, Single Port,
UK type, 45Degree,
Size: 25X38mm



APC630150
Face plate, Single Port,
UK type, Size: 25X38mm



APC630157
HDMI Face Plate
Length=15cm
UK Type, 25*50mm



APC630158
RCA Face Plate
Red/Green/Blue
UK Type, 25*50mm



APC630159
RCA Face Plate
Red/White
UK Type, 25*50mm



APC630151
HDMI Face Plate
UK Type, 25*50mm



APC630152
HDMI Face Plate
UK Type, 25*50mm



APC630153
USB A-A Face Plate
Length=15cm
UK Type, 25*50mm



APC630160
Face Plate, 1*HDMI
Size: 86x86mm



APC630161
Face Plate, 2*HDMI
Size: 86x86mm



APC630154
USB B-A Face Plate
Length=15cm
UK Type, 25*50mm



APC630155
VGA Face Plate
Length=15cm
UK Type, 25*50mm



APC630156
3.5mm Face Plate
Length=15cm
UK Type, 25*50mm



APC630162
Face Plate, 1*HDMI
Length: 15cm
Size: 86x86mm



APC630163
Face Plate, 2*HDMI
Length: 15cm
Size: 86x86mm



APC630164
Face Plate, 5*RCA
Size: 86x86mm



APC630165
Desktop Box
Size:86X86X21mm



APC630166
Desktop Box
Size:86X86X32mm



APC630167
Desktop Box
Size:86X86X37mm



APC630173
Face Plate 1 Port,
French Type,
Size:45X45mm



APC630174
Face Plate 1 Port,
French Type,
Size:22.5X45mm



APC630175
Face Plate 1 Port,
French Type,
Size:22.5X45mm



APC630168
Desktop Box
Size:86X86X45mm



APC630169
Desktop Box
Size:147X86X32mm



APC630170
Desktop Box, UK Type,
Size:86X146X35mm



APC630176
Face Plate 2 Port,
French Type,
Size:45X45mm



APC630177
Face Plate 1 Port,
French Type,
Size:45X45mm



APC630178
Face Plate 2 Port,
French Type,
Size:45X45mm



APC630171
Desktop Box
Size:147X86X37mm



APC630172
Desktop Box
Size:147X86X45mm

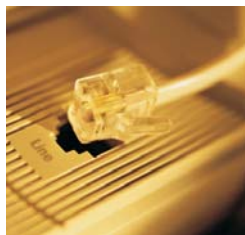

APC630179
Face Plate 2 Port,
French Type,
Size:45X45mm



APC630180
Face plate, Single Port,
French type, Size:50X50mm



APC630181
Face plate, Dual Ports,
French type, Size:50X50mm



APC630182
Face plate, Dual Ports,
French type, 45 Degree,
Size: 50x50mm



APC630183
Face Plate 1 Port,
French Type,
Size: 22.5x45mm



APC630184
Face Plate 1 Port,
French Type,
Size: 45x45mm



APC630193
HDMI Face Plate
Single Module, French Type.
Size: 45x45mm



APC630194
VGA Face Plate
Single Module, French Type.
Size: 45x45mm



APC630195
Face plate, French type,
Use for 45x45mm face plate,
Size: 80x80mm



APC630185
Face Plate 2 Port
French Type
Size: 45x45mm



APC630186
RJ11 Jack Face Plate
Single Module, French Type
Size: 45x22.5mm



APC630187
RJ11 Jack Face Plate
Single Module, French Type.
Size: 45x45mm



APC630196
Face Plate 1 Port, French Type,
Size: 80x80mm



APC630197
Face Plate 2 Port, French Type,
Size: 80x150mm



APC630198
Desktop Box, French Type,
Size: 80x80mm



APC630188
Cat5e Jack Face Plate
Single Module, French Type.
Size: 45x22.5mm



APC630189
Cat6 Jack Face Plate
Single Module, French Type.
Size: 45x22.5mm

APC630190
Cat5e Jack Face Plate
Single Module, French Type.
Size: 45x45mm

APC630191
Cat6 Jack Face Plate
Single Module, French Type.
Size: 45x45mm



APC630192
USB Face Plate
Single Module, French Type.
Size: 45x45mm



APC630199
Desktop Box, French Type,
Size: 80x150mm



APC630200
Desktop box, French Type,
Size: 80x80x45mm



APC630201
Desktop Box, French Type,
Size: 80x80x45mm

GERMAN FACE PLATE



APC630202
Desktop box, French Type,
Dual hole
Size:80X151X45mm



APC630203
UTP Cat5E Face Plate, 2 Ports,
German type, Size:80X65X32mm
APC630204
UTP Cat6 Face Plate, 2 Ports,
German type, Size:80X65X32mm



APC630205
STP Cat5E Face Plate, 2 Ports,
German type, Size:80X65X32mm
APC630206
STP Cat6 Face Plate, 2 Ports,
German type, Size:80X65X32mm

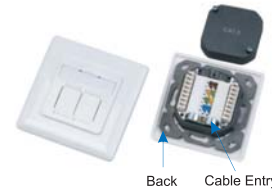

APC630215
STP Cat.6 Face Plate,
2 Ports, German Type,
Size:80X80mm

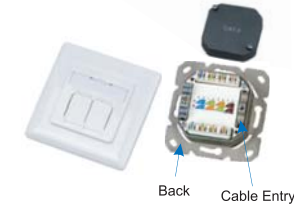

APC630216
STP Cat.6 Face Plate,
2 Ports, German Type,
Size:80X80mm



APC630217
Desktop Box
Australia Type
Size : 120x86x35mm



APC630207
UTP Cat5E Face Plate, 2 Ports,
German type, Size:80X80mm
APC630208
UTP Cat6 Face plate, 2 Ports,
German type, Size:80X80mm



APC630209
STP Cat5E Face Plate, 2 Ports,
German type, Size:80X80mm
APC630210
STP Cat6 Face plate, 2 Ports,
German type, Size:80X80mm



APC630211
Desktop Box, German type,
Size:80X80mm



APC630218
Face Plate 1Port
Australia Type
Size : 120x86mm

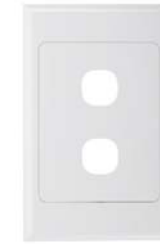

APC630219
Face Plate 2Ports
Australia Type
Size : 120x86mm



APC630220
Face Plate 3Ports
Australia Type
Size : 120x86mm



APC630212
STP Face Plate,
1 Port, German Type,
Size:80X80mm



APC630213
STP Face Plate,
2 Ports, German Type,
Size:80X80mm



APC630214
STP Face Plate,
3 Ports, German Type,
Size:80X80mm



APC630221
Face Plate 4Ports
Australia Type
Size : 120x86mm



APC630222
Face Plate 5Ports
Australia Type
Size : 120x86mm



APC630223
Face Plate 6Ports
Australia Type
Size : 120x86mm

AUSTRALIA FACE PLATE



APC630224
Face Plate 1 Port,
Size:70X115mm



APC630225
Face Plate 2 Port,
Size:70X115mm

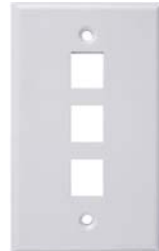

APC630226
Face Plate 3 Port,
Size:70X115mm



APC630233
Face Plate 6 Port,
Size:70X115mm



APC630234
Face Plate 1 Port,
Size:70X115mm



APC630235
Face Plate 2 Port,
Size:70X115mm



APC630227
Face Plate 4 Port,
Size:70X115mm

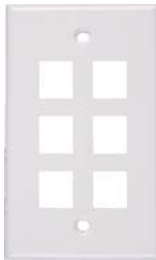

APC630228
Face Plate 6 Port,
Size:70X115mm



APC630229
Face Plate 1 Port,
Size:70X115mm

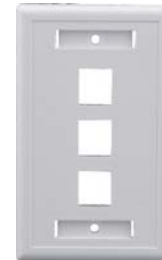

APC630236
Face Plate 3 Port,
Size:70X115mm



APC630237
Face Plate 4 Port,
Size:70X115mm



APC630238
Face Plate 6 Port,
Size:70X115mm



APC630230
Face Plate 2 Port,
Size:70X115mm



APC630231
Face Plate 3 Port,
Size:70X115mm



APC630232
Face Plate 4 Port,
Size:70X115mm



APC630239
Face Plate 1 Port,
Size:70X115mm



APC630240
Face Plate 2 Port,
Size:70X115mm



APC630241
Face Plate 4 Port,
Size:70X115mm



APC630242
Face Plate 1 Port,
120 type, 45 Degree
Size:70X115mm



APC630243
Face Plate 2 Ports,
120 type, 45 Degree
Size:70X115mm



APC630244
Face Plate 4 Ports,
120 type, 45 Degree
Size:70X115mm



APC630249-1P
Decora Insert Plate,
1 Port.



APC630249-2P
Decora Insert Plate,
2 Port.



APC630249-3P
Decora Insert Plate,
3 Port.



APC630245
Back Box
Size:70X115X36mm



APC630246-1P
Blank Wall Plate,
One Gang,
Size:70X115mm

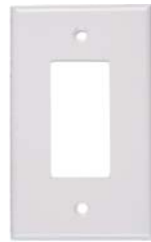

APC630247-1P
Decora Wall Plate,
Single Gang.



APC630249-4P
Decora Insert Plate,
4 Port.



APC630249-6P
Decora Insert Plate,
6 Port.



APC630250-1P
Decora Insert Plate,1 Port.
Use For Combine voice&A/V
Connectors.



APC630247-2P
Decora Wall Plate,
Dual Gang.

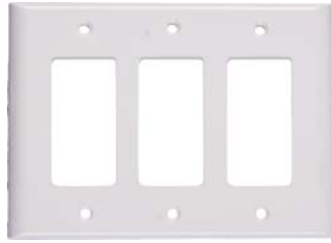

APC630247-3P
Decora Wall Plate,
Triple Gang.



APC630248
Blank Wall Plate Insert,
Decora Type.



APC630250-2P
Decora Insert Plate,2 Ports.
Use For Combine voice&A/V
Connectors.



APC630250-3P
Decora Insert Plate,3 Ports.
Use For Combine voice&A/V
Connectors.



APC630250-4P
Decora Insert Plate,4 Ports.
Use For Combine voice&A/V
Connectors.



APC630250-5P
Decora Insert Plate, 5 Ports.
Use For Combine voice&A/V
Connectors.



APC630250-6P
Decora Insert Plate, 6 Ports.
Use For Combine voice&A/V
Connectors.



APC630250-8P
Decora Insert Plate, 8 Ports.
Use For Combine voice&A/V
Connectors.



APC630252-8P
Decora Wall Plate,
8* Banana Binding Post



APC630252-16P
Decora Wall Plate,
14* Banana Binding Post+2* RCA



APC630253
HDMI Wall Plate,
1* HDMI Female-Female
90 Degree



APC630251-2P
Decora Wall Plate,
2* RCA



APC630251-3P
Decora Wall Plate,
3* RCA



APC630251-5P
AV Wall Face Plate Decora Inset
Component Video + Audio
(RGB + LR) 5*RCA



APC630254
Decora Wall Plate,
2* HDMI Female-Female
90 Degree



APC630255
Decora Wall Plate,
1* HDMI Female-Female



APC630256
Decora Wall Plate,
2* HDMI Female-Female



APC630252-2P
Decora Wall Plate,
2* Banana Binding Post



APC630252-4P
Decora Wall Plate,
4* Banana Binding Post



APC630252-6P
Decora Wall Plate,
6* Banana Binding Post



APC630257
Decora Wall Plate,
1* HDMI Female-Female
Length: 15cm



APC630258
Decora Wall Plate,
2* HDMI Female-Female
Length: 15cm



APC630259
Decora Wall Plate,
1* HDMI +1* F-81



APC630260
Decora Wall Plate,
1* HDMI + 1* F-81
Length: 15cm



APC630261
Decora Wall Plate,
1* HDMI + 2* RCA



APC630262
Decora Wall Plate,
1* HDMI + 3* RCA



APC630269
Decora Wall Plate,
HDMI+VGA



APC630270
Decora Wall Plate,
HDMI+3.5MM+ VGA



APC630271
Decora Wall Plate
With F connector



APC630263
Decora Wall Plate,
HDMI+RCA+F-81+RJ45+RJ11



APC630264
Decora Wall Plate,
HDMI+4*RJ45



APC630265
Decora Wall Plate,
1* VGA 15PIN Female-Female



APC630272
Decora Wall Plate,
RJ11 JACK+F-81



APC630273
Decora Wall Plate
With RJ11 Jack



APC630274
Decora Wall Plate
2* RJ11 Jack



APC630266
Decora Wall Plate,
2* VGA 15PIN Female-Female



APC630267
Decora Wall Plate,
F-81+ VGA



APC630268
Decora Wall Plate,
3.5MM+ VGA

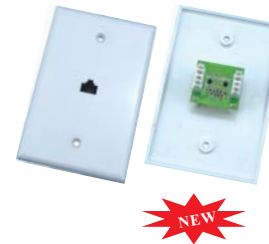

APC630275
Face Plate 1 Port
With RJ45 Jack
Size:79.8X123.8mm

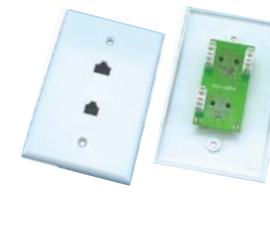

APC630276
Face Plate 2 Ports
With RJ45+RJ11 Jacks
Size:79.8X123.8mm



APC630277
Face Plate 3 Ports
With RJ45+RJ11+F Jacks
Size:79.8X123.8mm



APC630278
Telephone Wall Plate
Single Port, 6P4C



APC630279
Telephone Wall Plate
Dual Ports, 6P4C



APC630280
Coaxial Wall Plate
Single Port, F-81



APC630281
Coaxial Wall Plate
Dual Port, F-81



APC630282
Combination Telephone
and Coax Plate



APC630283
Combination Telephone
Modular Jack Assembly
6P4C



APC630284
Combination Telephone
Duplex Modular Jack Assembly
6P4C



APC630285
Modular Jack 6P4C and
AV. antenna Jack Wall Plate
6P4C



APC630286
Modular Wall
Phone Mounting 6P4C



APC640001
4P4C
Modular plug



APC640002
6P4C
Modular plug



APC640003
6P6C
Modular plug



APC640004
8P8C-Short
UTP Cat.5e modular plug



APC640005
8P8C
Modular plug



APC640006
8P8C-Shield
Cat.5e modular plug



APC640007
FTP Cat5e 8P8C
Modular Plug



APC640008
UTP Cat5e 8P8C
Modular Plug W/insert bar



APC640009
FTP Cat5e 8P8C
Modular Plug W/insert bar



APC640010
FTP Cat5e 8P8C
Modular Plug w/insert bar



APC640011
UTP Cat.5e modular Plug,
Coupler type, RJ45-RJ45, Long Type



APC640012
UTP Cat.5e modular Plug,
Coupler type, RJ45-RJ45, Long Type



APC640013
UTP Cat.5e Modular Plug
Tollesse type.



APC640014
UTP 10P10C Modular Plug



APC640015
FTP 10P10C Modular Plug



APC640022
FTP CAT6A 8P8C Modular Plug,UP 6Pin,
Down:2pin,Three-piece suit



APC640023
FTP CAT6A 8P8C Modular Plug,
UP:6Pin, Down:2pin,Three-piece suit



APC640024
FTP CAT7 8P8C Modular Plug,
UP 4Pin, Down:4pin,Three-piece suit



APC640016
UTP Cat.6 8P8C Modular Plug,
UP:4Pin, Down:4pin,



APC640017
FTP Cat.6 8P8C Modular Plug,
UP:4Pin, Down:4pin,



APC640018
UTP Cat.6 8P8C Modular Plug,
UP:4Pin, Down:4pin, W/insert bar



APC640025
LY-US014
UK 6P4C Modular Plug



APC640026
PVC BOOT For Cat5e/6 Round Cable
OD:6.0 or 6.5 mm



APC640027
PVC BOOT For Cat5e/6 Round Cable
A: OD6.0mm,B:OD6.5mm



APC640019
FTP Cat.6 8P8C Modular
Plug,UP 4Pin,Down:4pin, W/insert bar



APC640020
FTP Cat6 8P8C Modular Plug,
Four-piece suit



APC640021
UTP CAT6A 8P8C Modular Plug,
UP:6Pin, Down:2pin,Three-piece suit



APC640028
Small Boot OD5.5MM
Use For Cat5e Round Cable

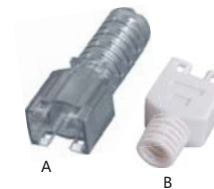

APC640029
Boot OD5.5mm
Use For Cat5e Round Cable
A:Long B:Short



APC640030
PVC BOOT
OD:6.0 mm
Use For Cat5e Round Cable



APC650001
PVC Boot OD:6.3 mm
Use For Cat5e/6 Round Cable



APC650002
PVC Boot
Use for RG59/6 Coaxial cable



APC650003
Swivel Jack for Handset
Avoid handset cord mess



APC650004
Swivel Jack for Handset
Avoid handset cord mess



APC650011
Modular triplex adapter
6P:2C/4C/6C



APC650012
Modular triplex adapter
8P8C



APC650013
Economy type wall jack
6P:2C/4C/6C



APC650005
Cable marker
A:5.5mm B:6.5mm



APC650006
Modular cord coupler
6P:2C/4C/6C



APC650007
Modular cord coupler
8P8C



APC650014
Duplex modular
6P:2C/4C



APC650015
MINI modular surface jack
6P:2C/4C



APC650016
Modular surface jack
6P:2C/4C/6C



APC650008
Modular duplex jack
6P:2C/4C/6C



APC650009
Modular duplex jack
8P8C



APC650010
Modular adapter 3 ways
6P:2C/4C/6C



APC650017
Modular surface jack
6P4C



APC650018
Modular surface jack
8P8C



APC650019
5 outlet modular
Jack 6P4C with cord



APC650020
US ADSL splitter 6P2C



APC650021
US ADSL splitter 6p2c



APC650022
US ADSL splitter 6p2c



APC650029
US ADSL splitter 6p2c



APC650030
US ADSL splitter 6p2c



APC650031
US ADSL splitter 6p2c



APC650023
US ADSL splitter 6p2c



APC650024
US ADSL splitter 6p2c



APC650025
US ADSL splitter 6p2c



APC650032
US ADSL splitter 6p6c



APC650033
US ADSL splitter 6p2c



APC650034
US ADSL splitter 6p2c



APC650026
US ADSL splitter 6p2c



APC650027
US ADSL splitter 6p2c



APC650028
US ADSL splitter 6p2c



APC650035
US ADSL splitter 6p2c



APC650036
US ADSL splitter 6p2c



APC650037
US ADSL splitter 6p2c

ADSL SPLITTER

[Http://www.apc-elec.com](http://www.apc-elec.com)



APC650038
US ADSL splitter 6P2C



APC650039
US ADSL splitter 6P2C



APC650040
US ADSL splitter 6P2C



APC650047
Belgian ADSL filter



APC650048
Swiss ADSL filter



APC650049
Italian ADSL filter



APC650041
US ADSL splitter 6p2c



APC650042
French ADSL splitter 6P2C



APC650043
UK ADSL splitter



APC650050
Danish ADSL splitter



APC650051
US VDSL splitter 6P2C



APC650052
US VDSL splitter 6P2C



APC650044
UK ADSL splitter 6P2C



APC650045
UK ADSL splitter 6P2C



APC650046
UK ADSL splitter 6P2C



APC650053
US VDSL central splitter



APC650054
Germany VDSL
central splitter



APC650055
French VDSL splitter 8P8C



APC653001
Testing open circuit, short circuit, jumper wire or cross-talk interference for CAT5E, CAT6, coaxial and telephone cable
Measuring cable length and locating the position of open circuit and short circuit
Dynamically calibrates cable length to makes length measurement as accurate as 95%
Packing: Gift box



APC653004
Cable Tester
For UTP/STP RJ45,BNC Cable.
Packing: A: Blister card B: Gift box



APC653005
Cable Tester
For UTP/STP RJ45,BNC.
Packing: A: Blister card B: Gift box

APC653002
Testing open circuit, short circuit, jumper wire or cross-talk interference for CAT5E, CAT6, coaxial and telephone cable
Measuring cable length and locating the position of open circuit and short circuit
Dynamically calibrates cable length to makes length measurement as accurate as 95%
Judge continuity of the cables or wires.
Track the cables or wires, and diagnose the break point.
Receive the tone signal on the cables or wires(telephone line)
Identify the state in the working telephone line(clear, ring, busy)
Send a single solid tone or a dual alternating tone to the object cables or wires.
Packing: Gift box



APC653006
Cable Tester
For UTP/STP RJ45 Cable.
Packing: A: Blister card B: Gift box



APC653007
Cable Tester
For UTP/STP RJ45,BNC Cable.
Packing: A: Blister card B: Gift box



APC653003
Testing open circuit, short circuit, jumper wire or cross-talk interference for CAT5E, CAT6, coaxial and telephone cable
Measuring cable length and locating the position of open circuit and short circuit
Dynamically calibrates cable length to makes length measurement as accurate as 95%
Judge continuity of the cables or wires.
Track the cables or wires, and diagnose the break point.
Receive the tone signal on the cables or wires(telephone line)
Identify the state in the working telephone line(clear, ring, busy)
Send a single solid tone or a dual alternating tone to the object cables or wires.

Locate cable and there are 24PCS Far-end Passive test Dongle (ID1 TO ID24)
(Max trace up to 60PCS ID Dongle)



APC653008
Cable Tester
For UTP/STP RJ45 & RJ11/RJ12 Cable.
Packing: A: Blister card B: Gift box



APC653009
Cable Tester
For UTP/STP RJ45, RJ11/RJ12&BNC Cable.
Packing: A: Blister card B: Gift box



APC653010
Cable Tester
For UTP/STP RJ45, RJ11/RJ12 & BNC Cable.
Packing: A: Blister card B: Gift box



APC653011
Cable Tester
For UTP/STP RJ45, RJ11/RJ12
Packing: Gift box



APC653016
Cable Tester
For UTP/STP RJ45,
RJ11/12&BNC Cable.
Packing: Blister card



APC653017
Cable Tester
For UTP/STP RJ45 & RJ11/RJ12 Cable.
Packing: Blister card



APC653012
Cable Tester(4 in 1)
For UTP/STP RJ45,
RJ11/RJ12, BNC & USB Cable.
Packing: A: Blister card B: Gift box



APC653013
Cable Tester(5 in 1)
For UTP/STP RJ45, RJ11/RJ12,
BNC ,USB&IEEE1394 Cable.
Packing: Gift box



APC653018
Cable Tester
Testing open circuit, short circuit, jumper wire or cross-talk interference for CAT5E, CAT6, coaxial and telephone cable
Measuring cable length and locating the position of open circuit and short circuit
Dynamically calibrates cable length to makes length measurement as accurate as 95%
Packing: Gift box



APC653014
Cable Tester
For UTP/STP RJ45,
RJ11/RJ12,BNC,USB Cable.
Packing: Gift box



APC653015
Cable Tester(Mini)
For UTP/STP RJ45
Packing: Gift box



APC653019
Cable Tester
Testing open circuit, short circuit, jumper wire or cross-talk interference for CAT5E, CAT6, coaxial and telephone cable
Measuring cable length and locating the position of open circuit and short circuit
Dynamically calibrates cable length to makes length measurement as accurate as 95%
Packing: Gift box

Locate cable and there are 8PCS Far-end Passive test Dongle (ID1 TO ID8)
(Max trace up to 60PCS ID Dongle)





APC653020
Cable Tester
Testing open circuit, short circuit, jumper wire or cross-talk interference for CAT5E, CAT6, coaxial and telephone cable
Measuring cable length and locating the position of open circuit and short circuit
Dynamically calibrates cable length to makes length measurement as accurate as 95%
Packing: Gift box



APC653021
Cable Tracker
Line DC detecting anode and cathode determinant
Open, short and cross testing for RJ45,RJ11 cable
Easily tracking the correspondent cable
Earphone offered can be used to prevent interference from the outside
Easily work as usual while putting on the light switch in the dark environment
Packing: Gift box



APC653024
Cable Tracker
Line DC detecting anode and cathode determinant
Open, short and cross testing for RJ45,RJ11 cable
Easily tracking the correspondent cable
Earphone offered can be used to prevent interference from the outside
Easily work as usual while putting on the light switch in the dark environment
Packing: Gift box



APC653025
Cable Tracker
Line DC detecting anode and cathode determinant
Open, short and cross testing for RJ45,RJ11 cable
Easily tracking the correspondent cable
Earphone offered can be used to prevent interference from the outside
Easily work as usual while putting on the light switch in the dark environment
Packing: Gift box



APC653022
Cable Tester
Testing open circuit, short circuit, jumper wire or cross-talk interference for CAT5E, CAT6, coaxial and telephone cable
Simply and easily using, big screen to display testing results
Portable unit with long battery life(50 hours)
Automatically time-delay shut off
Self-checking function and automatically compensates any change in battery capacity or ambient temperature
Packing: Gift box



APC653023
Cable Tracker
Judge continuity of the cables or wires.
Track the cables or wires, and diagnose the break point.
Receive the tone signal on the cables or wires(telephone line)
Identify the state in the working telephone line(clear, ring, busy)
Send a single solid tone or a dual alternating tone to the object cables or wires.
Packing: Gift box



APC653026
Cable Tester
Judge continuity of the cables or wires.
Track the cables or wires, and diagnose the break point.
Receive the tone signal on the cables or wires(telephone line)
Identify the state in the working telephone line(clear, ring, busy)
Send a single solid tone or a dual alternating tone to the object cables or wires.
Packing: Gift box



APC653027
Cable Tracker
Line DC detecting anode and cathode determinant
Open, short and cross testing for RJ45,RJ11 cable
Easily tracking the correspondent cable
Earphone offered can be used to prevent interference from the outside
Easily work as usual while putting on the light switch in the dark environment
Packing: Gift box



APC653028
 Testing HDMI cable
 Testing open, short, cross circuit and cable assignment
 Each individual core is automatically scanned
 Individual LED to show the defective core
 Auto and manual control options
 Packing: Gift box



APC653029
 Voltage Detector
 The LY-CT029 is useful for identifying hot and neutral conductors, finding a break in a wire, and detecting the presence of AC voltage at outlets, switches, circuit breakers, fuses, and wires and cables, including Romex.
 Note: Round cords may have twisted conductors. Check for hot conductors by sliding the unit along the cord.
 Note: The LY-CT029 can be used to find a break in a wire:
 To find a break in a hot conductor, trace the wire until the signal stops.
 To find a break in a neutral conductor, connect a load between the hot and neutral.
 Trace the wire until the signal stops.
 Turn the unit on by rotating the battery cap so that the pointer is in the ON position.
 Test the unit on a known live circuit before each use.
 If the unit does not function as expected on a known live circuit, replace the batteries.
 Place the probe tip on or near the circuit or unit to be tested.
 Tone and flashing LED indicate the presence of voltage (50 VAC to 1000 VAC).
 Note: The voltage detector cannot detect voltage on armored cable; on sheathed nonmetallic cable that is saturated with water; or on cable in conduit, behind panels, or in metallic enclosures.
 Packing: Gift box

Indicators: LED and Tone
 Voltage Range: 50VAC to 1000VAC
 Frequency Range: 50Hz to 500Hz
 Measurement Categories:
 Category III, 1000 V per UL 61010B-1
 Category IV, 600 V per IEC 61010-1, 2nd edition
 Category III, 1000 V per UL 61010B-1
 Category IV, 600 V per IEC 61010-1, 2nd edition
 Operating Conditions:
 Temperature: 0°C to 40°C (32°F to 104°F)
 Less than 80% relative humidity (noncondensing)
 Altitude: 2000 m (6500') maximum
 Indoor use only.
 Pollution Degree: 2
 Battery: Two 1.5 volt batteries (AAA, NEDA 24A or IEC LR03)

APC653030
 Laser distance meter tester

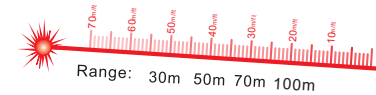

EASY FUNCTIONALITY!
HIGH PRECISION!
FAST RESULTS!

Length Measurement
 Continuous measurement. Any line, height, width and depth can be added or subtracted.

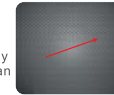

Area Measurement
 The device can automatically calculate the area after measuring its length and width.



Volume Measurement
 The device can automatically calculate the volume after measuring its length, width and height.



Pythagoras Measurement
 The device can automatically calculate the third after measuring two sides of triangle, by Pythagoras.



Major Application:
 Interior decoration & construction technology
 Construction project supervision & on site inspection
 Fast forensics from accident site for traffic police
 Real estate development and evaluation, fire evaluation
 Public facilities planning, landscaping planning and application in telecommunication industry, etc

Specifications:
 Measuring Range: ± 1.5mm
 Laser Type: 635nm ≤ 1mW; II
 Battery Type: AAA alkaline battery (2x1.5v)
 Product Dimension: 115x52x28mm
 Packing: Gift box

APC653031
 Visual Fault Locator
 Wavelength Measurement: 650nm +/- 10nm
 Output Power: 1mW (Optional)
 Optical Fiber Connector: Gm 2.5mm
 Flicker Frequency Rate: 1Hz
 Operating Temperature: 14 to 113 F
 Operating Humidity: 30 to 90%
 Size: 4.64" x 1.32" x 0.75"
 Packing: Gift box





APC660001
Crimping Tool With Tester
For 8P+6P+4P
and Test UTP/STP RJ45 Cables



APC660002
Crimping Tool
LY-T2094C Use for 4P4C
LY-T2096C Use for 6P6C
LY-T210C Use for 8P8C

APC660003
Crimping Tool
Use for 8P8C
(Available for stripping round cable)



APC660011
Crimping Tool
For 8P+6P+4P



APC660012
Crimping Tool
A:For 8P+6P
B:For 6P+4P



APC660013
Crimping Tool
A:For 8P+6P
B:For 6P+4P



APC660004
Crimping Tool
Use for 8P8C/RJ45



CRIMPING TOOL
APC660005 For 8P8C/RJ45
APC660006 For 6P6C/4C/2C(RJ11)



APC660007
Crimping Tool
For 8P8C/RJ45



APC660014
Crimping Tool
A:For 8P+6P
B:For 6P+4P



APC660015
Crimping Tool
A:For 8P+6P
B:For 6P+4P



APC660016
Crimping Tool
For 8P8P/RJ45,6P4C/RJ11
With Round Cable Stripper



APC660008
Crimping Tool
For 8P+6P



APC660009
Crimping Tool
Use for 8P+6P+4P



APC660010
Crimping Tool
A:Use for 8P+6P
B:Use for 6P+4P



APC660017
Crimping Tool
For 8P+6P+4P



APC660018
Crimping Tool
Use for 8P+6P+4P



APC660019
Crimping Tool
A:For 8P+6P
B:For 6P+4P



APC660020
Crimping Tool
For 8P/6P/4P
With Cutting and stripping



APC660021
Crimping Tool
Use for 8P+6P



APC660022
Crimping Tool
Use for 8P+6P/DEC+4P



APC660029
Crimping Strips & Cuts Tool
For 8P8C/RJ45



APC660030
Crimping Strips & Cuts Tool
For 6P4C/RJ11



APC660031
HDMI Crimping Tool
For HDMI 28/30 AWG



APC660023
Crimping Tool
Use for 10P/8P+6P/DEC+4P



APC660024
Crimping Tool
For 6P4C+UK 6P4C Plug



APC660025
Crimping Tool
Use for 8P+6P+4P
and Cat6 RJ45 Plug-AMP.



APC660032
Crimping Tool
For 8P8C/RJ45 Plug



APC660033
Crimping Tool
For 8P8C/6P6C/4P4C



APC660034
Crimping Tool
For 8P8C/6P6C/4P4C



APC660026
Crimping Tool
Use for 6P4C/RJ11
With 4P4C Cover



APC660027
Crimping Tool
Use for 8P8C+6P4C



APC660028
Crimping Tool
Use for 8P+6P+4P



APC660035
Crimping Tool
For 8P8C/6P6C



APC660036
Crimping Tool
For 8P8C/6P6C/4P4C



APC660037
Crimping Tool
For 8P8C/RJ45



APC660038
Crimping Tool
For RG59&RG6 F Connectors.



APC660039
Crimping Tool
For RG59&RG6 F Connectors
With 19.3mm or 20.3mm or 21.0mm



APC660040
Crimping Tool
For RG59&RG6 F Connectors
With 19.3mm,20.3mm & 21.0mm



APC660047
Crimping Tool
For RG59/RG6 F Connectors
Distance:19.3/19.7/20.3/21.0



APC660048
3 in 1 Crimping Tool
For Waterproof
Connectors:F/BNC/RCA



APC660049
Crimping Tool
For RG59,RG6 F Connectors



APC660041
Crimping Tool
For RG59&RG6 F Connectors.



APC660042
Crimping Tool
For RG59&RG6 F/RCA/BNC Connectors.



APC660043
Crimping Tool
For RG59&RG6 F Connectors.



APC660050
Crimping Tool
For RG59/RG6 F,BNC&RCA
connectors and different
length of connectors



APC660051
Crimping Tool
For RG59/RG6 F,BNC&RCA
connectors and different
length of connectors



APC660052
3 in 1 Crimping Tool
For Waterproof
Connectors:F/BNC/RCA



APC660044
Crimping Tool
For RG59&RG6 F Connectors.



APC660045
Crimping Tool
For RG59/6/7/11 Cable
With F,RCA,BNC,IEC
and right angle Connectors



APC660046
Crimping Tool
For RG59/RG6/RJ11
F,BNC & RCA connectors.



APC660053
Crimping Tool
For RG59,RG6&RG11 F type
Compression connectors



APC660054
Crimping Tool
For RG59/RG6/RJ11
F,BNC & RCA connectors.



APC660055
Crimping Tool
For RG59/RG6/RJ11
F,BNC & RCA connectors.

CRIMPING TOOLS

[Http://www.apc-elec.com](http://www.apc-elec.com)



APC660056
Pin-Extrator 3 in 1 Tool one end to enlarge space between shield and insulation for RG59, another end for RG6, the other end lock F connector into tool socket and twist it onto a stripped cable end



APC660057
F Connector Lock Tool
Simply lock the F connector into tool socket and twist it onto a stripped cable end.



APC660058
F Connector Lock



APC-T336FM

APC-T436FM

APC-T536FM



APC660059
Crimping Tool and non-ins.terminal(solder) 10-22 AWG/22-26 AWG, telephone connectors(5.5-0.35mm2)



APC660060
Crimping Tool
Crimping D-SUB 26-28 AWG wire, (BUTT-INS.)connectors 22-26 AWG wire,(telephone)



APC660061
IDC-TYPE Crimping Tool
Crimping from height 6mm distance to 27.5mm (max.55mm width)



APC660062
Economic Crimping Tool
For cable tie thickness up to 2.3mm



APC660063
Crimping Tool
For UR/UY/UG



APC660064
Crimping Tool
For UR/UY/UG



APC660065
Hiroshe 8P8C/RJ45 shielded plugs



APC660066
For 8P8C/RJ45 modular plug

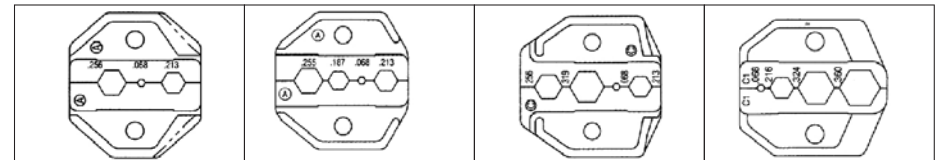

APC-T536A/APC-T436A/APC-T336A
Die P/N: 3A
Specifications:0.256"/0.068"/.213"
Crimping cable size:RG58,59,62

APC-T532A/APC-T432A/APC-T236A
Die P/N: 2A
Specifications:0.256"/0.068"/.213"
6.48/4.75/1.73/5.41mm
Crimping cable size:RG58,59,62, 174

APC-T536C/APC-T436C/APC-T336C
Die P/N: 3C
Specifications:.256"/.319"/.068"/.213"
6.50/8.10/1.73/5.41mm
Crimping cable size:RG58,59,62, 6

APC-T532C1/APC-T436C1/APC-T336C1
Die P/N: 2A
Specifications:.068"/.216"/.213"/.360
1.73/5.49/6.23/9.14mm
Crimping cable size:RG58,59,62, 6

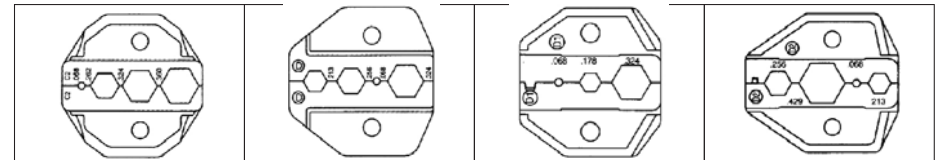

APC-T536C2/APC-T436C2/APC-T336C2
Die P/N: 3C2
Specifications: .068"/.262"/.324"/.360"
Crimping cable size:CATV/F-connectors
RG59,6

APC-T536D/APC-T436D/APC-T336D
Die P/N: 3D
Specifications: .213"/.256"/.068"/.324"
Crimping cable size:RG58,59,62,6

APC-T536D1/APC-T436D1/APC-T336D1
Die P/N: 3D1
Specifications: .068"/.178"/.324"
Crimping cable size:RG58,6,174

APC-T536D2/APC-T436D2/APC-T336D2
Die P/N: 3D2
Specifications: .256"/.429"/.068"/.213"
Crimping cable size:RG58,59,62,11,8,213

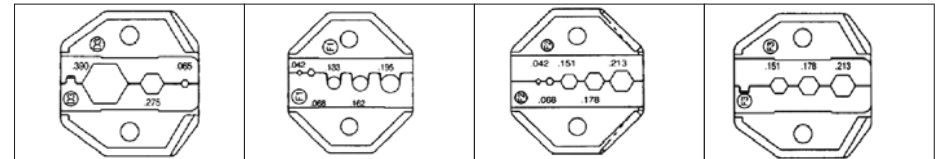

APC-T536D3/APC-T436D3/APC-T336D3
Die P/N: 3D3
Specifications:.390"/.275"/.065"
9.9/6.98/1.65mm
Crimping cable size:RG213,6,8,59

APC-T536F1/APC-T436F1/APC-T336F1
Die P/N: 3F1
Specifications:.042"/.068"/.133"/.162"/.195
1.07/1.73/3.38/4.11/4.95mm
Crimping cable size:Fiber Optic SMA(Oval Type)

APC-T536F2/APC-T436F2/APC-T336F2
Die P/N: 3F2
Specifications:.042"/.068"/.151"/.178"/.213
1.07/1.73/3.84/4.52/5.41mm
Crimping cable size:Optic SMA,SMB Conn
RG58,174,Belden 8281

APC-T536F3/APC-T436F3/APC-T336F3
Die P/N: 3F3
Specifications: .151"/.178"/.213
3.84/4.52/5.41mm
Crimping cable size:RG58, 174, 179

CRIMPING TOOLS

<p>APC-T536F4/APC-T436F4/APC-T336F4 Die P/N: 3F4 Specifications: .151", .178", .134", .139", .190" 3.944, 5.293, 4.015, 5.314, 83mm Crimping cable size: Fiber Optic ST, SC, LC connectors</p>	<p>APC-T536G/APC-T436G/APC-T336G Die P/N: 3G Specifications: .043", .068", .100", .137", .213", .255" 1.091, 1.702, 5.424, 4.815, 4.116, 4.8mm Crimping cable size: RG58, 59, 62, 174 Fiber Optic</p>	<p>APC-T536G1/APC-T436G1/APC-T336G1 Die P/N: 3G1 Specifications: .042", .068", .190", .213" 1.071, 1.734, 83/5.41mm Crimping cable size: RG58 Fiber Optic</p>	<p>APC-T536G2/APC-T436G2/APC-T336G2 Die P/N: 3G2 Specifications: .235", .128", .065", .042" 5.97/3.25/1.65/1.07mm Crimping cable size: RG58, 59, 62, 142</p>

<p>APC-T536G3/APC-T436G3/APC-T336G3 Die P/N: 3G3 Specifications: .042", .068", .255", .324" 1.071, 1.736, 48/9.23mm Crimping cable size: RG174, 58, 59, 6</p>	<p>APC-T536G4/APC-T436G4/APC-T336G4 Die P/N: 3G4 Specifications: .042", .068", .178", .278", .255" 1.071, 1.734, 52/7.8/6.48mm Crimping cable size: RG59, 62, 174</p>	<p>APC-T536H1/APC-T436H1/APC-T336H1 Die P/N: 3H1 Specifications: .255", .320", .350" 6.48/8.13/4.52/8.89mm Crimping cable size: CATV F Connectors RG59, 6</p>	<p>APC-T536H2/APC-T436H2/APC-T336H2 Die P/N: 3H1 Specifications: .320", .210", .185" 8.13/5.33/4.70mm Crimping cable size: RG58, 6</p>

<p>APC-T532I/APC-T432I/APC-T236I Die P/N: 3I Specifications: .248", .204", .090", .068", .311" 6.30/5.18/2.29/1.72/7.90mm Crimping cable size: RG58, 59, 5, 174</p>	<p>APC-T536J/APC-T436J/APC-T336J Die P/N: 3J Specifications: .042", .068", .078", .128", .151", .178" 1.071, 1.731, 38/3.25/3.84/4.52mm Crimping cable size: RG174, 179, Belden 8218 Fiber Optic</p>	<p>APC-T536K/APC-T436K/APC-T336K Die P/N: 3K Specifications: .109", .128", .429" 2.54/3.25/10.90mm Crimping cable size: RG8, 11, 174, 179, 213</p>	<p>APC-T536K2/APC-T436K2/APC-T336K2 Die P/N: 3K2 Specifications: .068", .266", .429" 1.73/6.50/10.90mm Crimping cable size: RG11, 59, 62</p>

<p>APC-T536K3/APC-T436K3/APC-T336K3 Die P/N: 3K3 Specifications: .256", .068", .295" 6.50/1.73/7.49mm Crimping cable size: RG59, 6</p>	<p>APC-T536K4/APC-T436K4/APC-T336K4 Die P/N: 3K4 Specifications: .100", .128", .190", .213" 2.54/3.25/4.83/5.41mm Crimping cable size: RG58, 174 Fiber Optic</p>	<p>APC-T536K5/APC-T436K5/APC-T336K5 Die P/N: 3K5 Specifications: .080", .100", .429" 2.03/2.54/10.90mm Crimping cable size: RG11, 174, 213</p>	<p>APC-T536K6/APC-T436K6/APC-T336K6 Die P/N: 3K6 Specifications: .429", .075", .075" 10.90/1.91/1.91mm Crimping cable size: RG11, 213</p>

<p>APC-T536M/APC-T436M/APC-T336M Die P/N: 3M Specifications: .228", .068", .305" 5.79/1.73/7.75mm Crimping cable size: RG58, 59, 6, 62, 142</p>	<p>APC-T532PA/APC-T432PA/APC-T236PA Die P/N: 2PA Specifications: .255", .213", .100", .068", .324" 6.48/5.41/2.50/1.72/8.23mm Crimping cable size: RG58, 59, 6, 2</p>	<p>APC-T536T1/APC-T436T1/APC-T336T1 Die P/N: 3T1 Specifications: .028", .039", .047", .100", .128", .151" 0.71/0.99/1.19/2.54/3.25/3.84mm Crimping cable size: RG174, 178, 179, 180, 187</p>	<p>APC-T536V/APC-T436V/APC-T336V Die P/N: 3V Specifications: .043", .100", .151" 1.09/1.75/2.54/3.25/3.84/5.41mm Crimping cable size: RG174, 178, 179, 180, 187</p>

<p>APC-T536V1/APC-T436V1/APC-T336V1 Die P/N: 3V1 Specifications: .047", .178", .217", .267", .330" 1.19/1.734, 52/5.16/5.08/8.38mm Crimping cable size: RG59, 62, 6, 174 Fiber Optic</p>	<p>APC-T536Y/APC-T436Y/APC-T336Y Die P/N: 3Y Specifications: .044", .057", .068", .220", .213" 1.12/1.45/1.73/5.59/5.41mm Crimping cable size: RG58</p>	<p>APC-T536Y1/APC-T436Y1/APC-T336Y1 Die P/N: 3Y1 Specifications: .216", .069" 5.44/1.75mm Crimping cable size: RG58 (Oval Type)</p>	<p>APC-T536Y2/APC-T436Y2/APC-T336Y2 Die P/N: 3Y2 Specifications: .042", .240" 1.07/6.10mm Crimping cable size: Pin Terminal, Insulator or non-insulated ferrules (Oval Type)</p>

<p>APC-T532C/APC-T432C/APC-T236C Die P/N: 2C Specifications: AWG 20-18/16-14/12-10 DIN 0.5-1/1.5-2/5.4-6mm Crimping cable size: Non-insulated Terminal or Open Barrel Terminal</p>	<p>APC-T532CL/APC-T432CL/APC-T236CL Die P/N: 2CL (LOCATOR) Specifications: AWG 20-18/16-14/12-10 DIN 0.5-1/1.5-2/5.4-6mm Crimping cable size: Non-insulated Terminal or Open Barrel Terminal</p>	<p>APC-T532C2/APC-T432C2/APC-T236C2 Die P/N: 2C2 Specifications: AWG 20-18/16-14 DIN 0.5-1/1.5-2/5.5mm Crimping cable size: Non-insulated Terminal or Open Barrel Terminal</p>	<p>APC-T532C3/APC-T432C3/APC-T236C3 Die P/N: 2C3 Specifications: AWG 24-30/18-22 DIN 0.25-0.05/1.0-0.5mm Crimping cable size: D-Sub Terminal</p>

<p>APC-T532C4/APC-T432C4/APC-T236C4 Die P/N: 2C4 Specifications: AWG 24-30/20-22 DIN 0.25-0.08/0.75-0.5mm Crimping cable size: D-Sub Terminal</p>	<p>APC-T536E/APC-T436E/APC-T336E Die P/N: 3E Specifications: AWG 22/20/18/16/14/12 DIN 0.25/0.75/1.0/1.5/2.5/4mm Crimping cable size: Pin Terminal insulated or Non-insulated Terminal</p>	<p>APC-T536S/APC-T436S/APC-T336S Die P/N: 3S Specifications: AWG 10/8/6 DIN 6/10/16mm Crimping cable size: Pin Terminal insulated or Non-insulated Terminal</p>	<p>APC-T536E2/APC-T436E2/APC-T336E2 Die P/N: 3E2 Specifications: AWG 22/20/18/16/14/12/10/8/6 DIN 0.5/0.75/1.0/1.5/2.5/4/6/10/16mm Crimping cable size: Pin Terminal insulated or Non-insulated Terminal</p>

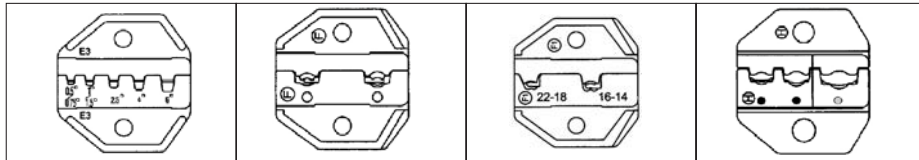

<p>APC-T536E3/APC-T436E3/APC-T336E3 Die P/N: 3E3 Specifications: AWG 22/20/18/16/12/10 DIN 0.5/0.75/1.0/1.5/2.5/4/6mm² Crimping cable size: Pin Terminal Insulated or Non-Insulated Terminal</p>	<p>APC-T532F/APC-T432F/APC-T236F Die P/N: 2F Specifications: AWG 22-18/16-14 DIN 0.5-1.0/1.5-2.5mm² Crimping cable size: Insulated Flag Terminal</p>	<p>APC-T532F1/APC-T432F1/APC-T236F1 Die P/N: 2F1 Specifications: AWG 22-18/16-14 DIN 0.5-1.0/1.5-2.5mm² Crimping cable size: Insulated Flag Terminal</p>	<p>APC-T536H/APC-T436H/APC-T336H Die P/N: 3H Specifications: AWG 22-18/16-14/12-10 DIN 0.5-1.0/1.5-2.5/4-6mm² Crimping cable size: Insulated Terminal</p>
--	--	--	---

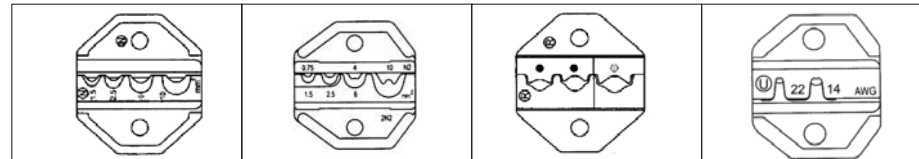

<p>APC-T536N/APC-T436N/APC-T336N Die P/N: 3N Specifications: AWG 22-18/16-14/12-10/8 DIN 1.5/2.5/6/10mm² JIS 1.25/2.0/5.5/8mm² Crimping cable size: Non-Insulated Terminal</p>	<p>APC-T536N2/APC-T436N2/APC-T336N2 Die P/N: 3N2 Specifications: AWG 18-16/14/12-10/8 DIN 0.75-1.5/2.5/4-6/10mm² Crimping cable size: Non-Insulated Terminal</p>	<p>APC-T536R/APC-T436R/APC-T336R Die P/N: 3R Specifications: AWG 22-18/16-14/12-10 JIS 1.25/2.0/5.5mm² Crimping cable size: Vinyl Insulated w/o Copper-Sleeve</p>	<p>APC-T536U/APC-T436U/APC-T336U Die P/N: 3U Specifications: AWG 14-22 DIN 2.5-0.5mm² Crimping cable size: Non-Insulated, Open Barrel & D-sub, V.35 Terminal</p>
---	--	---	--

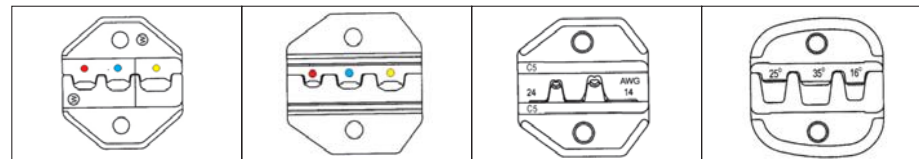

<p>APC-T536W/APC-T436W/APC-T336W Die P/N: 3W Specifications: AWG 22-18/16-14/12-10 DIN 0.5-1.0/1.5-2.5/4-6mm² Crimping cable size: Insulated Terminal</p>	<p>APC-T536W1/APC-T436W1/APC-T336W1 Die P/N: 3W1 Specifications: AWG 28-16 Crimping cable size: Insulated Terminal</p>	<p>APC-T532C5/APC-T432C5/APC-T236C5 Die P/N: 2C5 Specifications: AWG 24/14 DIN 0.25/2.5mm² Crimping cable size: Pin Terminal Insulated or Non-Insulated Ferrules</p>	<p>APC-T532D/APC-T432D/APC-T236D Die P/N: 2D Specifications: AWG 4/2/6 DIN 25/35/16mm² Crimping cable size: Pin Terminal Insulated or Non-Insulated Ferrules</p>
---	---	--	--

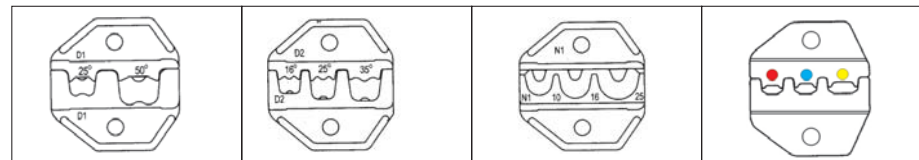

<p>APC-T532D1/APC-T432D1/APC-T236D1 Die P/N: 2D1 Specifications: AWG 4/1 DIN 25/50mm² Crimping cable size: Pin Terminal Insulated or Non-Insulated Ferrules</p>	<p>APC-T532D2/APC-T432D2/APC-T236D2 Die P/N: 2D2 Specifications: AWG 6/4/2 DIN 18/25/35mm² Crimping cable size: Pin Terminal Insulated or Non-Insulated Ferrules</p>	<p>APC-T536N1/APC-T436N1/APC-T336N1 Die P/N: 3N1 Specifications: AWG 8/6/4 DIN 10/16/25mm² Crimping cable size: Non-Insulated Terminal</p>	<p>APC-T301 Die P/N: LY-T301 DIE is unchangeable Specifications: AWG 22-18/16-14/12-10 DIN 0.5/1.0/1.5/2.5/4-6mm² Crimping cable size: Insulated Terminal</p>
---	--	--	---

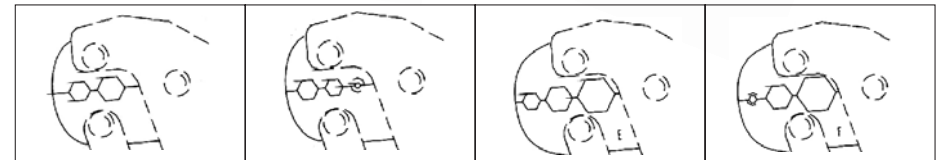

<p>APC-T160C Ratchet type: NO/YES Specifications: 2557/3227 6.48/8.20mm Crimping cable size: RG59, 62, 6</p>	<p>APC-T106D Ratchet type: NO/YES Specifications: 2557/2137/0687 6.48/5.40/1.72mm Crimping cable size: RG59, 62, 6</p>	<p>APC-T106E Ratchet type: NO/YES Specifications: 2137/3227/4487 5.40/8.20/11.40mm Crimping cable size: RG58, 6, 11, 213</p>	<p>APC-T106F Ratchet type: NO/YES Specifications: 1007/3227/4737 2.54/8.20/12.1mm Crimping cable size: RG6, 11, 213</p>
---	---	---	--

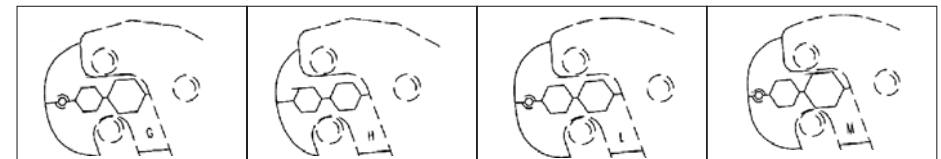

<p>APC-T106G Ratchet type: NO/YES Specifications: 1007/3227/4737 2.54/8.20/12.1mm Crimping cable size: RG6, 11, 213 Belden 8281</p>	<p>APC-T106H Ratchet type: NO/YES Specifications: 3227/3597 8.20/9.12mm Crimping cable size: F-59, 62, 6</p>	<p>APC-T106L Ratchet type: NO/YES Specifications: 1007/3597/4067 2.54/9.12/10.30mm Crimping cable size: F59, 6, 11 & UHF-58, 8</p>	<p>APC-T106M Ratchet type: NO/YES Specifications: 1007/3597/4757 2.54/9.12/12.08mm Crimping cable size: F59, 6, 11</p>
--	---	---	---

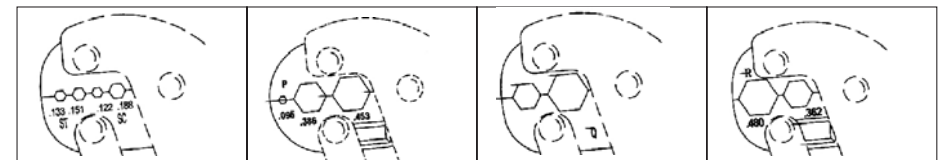

<p>APC-T106N Ratchet type: NO/YES Specifications: 1337/1517/1227/1887 3.38/3.84/3.10/4.78mm Crimping cable size: ST/SC Fiber optic</p>	<p>APC-T106P Ratchet type: NO/YES Specifications: 0597/3867/4537 2.41/8.80/11.50mm Crimping cable size: F-59, 6, 11 & UHF-58, 8</p>	<p>APC-T106Q Ratchet type: NO/YES Specifications: 3247/4707 8.23/11.94mm Crimping cable size: F-59, 6, 11, 213</p>	<p>APC-T106R Ratchet type: NO/YES Specifications: 4807/3627 12.19/9.19mm Crimping cable size: F-59, 6, 11</p>
---	--	---	--



<p>APC-T106S Ratchet type: NO/YES Specifications: 1027/4067 1.93/8.60mm Crimping cable size: UHF-8</p>	<p>APC-T106X Ratchet type: NO/YES Specifications: 0767/3387 1.93/8.60mm Crimping cable size: TWNA</p>	<p>APC-T106Z Ratchet type: NO/YES Specifications: 2177/3247/0.0687 5.48/8.22/1.72mm Crimping cable size: RG58, 6</p>	<p>APC-T106QD Ratchet type: NO/YES Specifications: 0967/4107/4757 2.44/10.40/12.08mm Crimping cable size: UHF-8, F-11</p>
---	--	---	--



APC660067
Punch Down Tool
with Easy Stripper
For UTP/STP Round Cable



APC660068
Punch Down Tool
with Easy Stripper
For UTP/STP Round Cable



APC660069
Easy Stripper
For UTP/STP Round Cable



APC660076
Coaxial Stripper
with 3 Blades Model
For RG58/59/62/3C/4C



APC660077
Coaxial Stripper
with 2 Blades Model
For RG59/62/6/4C/5C



APC660078
Coaxial Stripper
For RG58/59/6 Cables



APC660070
Stripper & Cuts Tool
For UTP/STP round cable
or flat telephone cable



APC660071
Stripper & Cuts Tool
For UTP/STP round cable
or flat telephone cable



APC660072
Stripper & Cuts Tool
For UTP/STP round cable
or flat telephone cable



APC660079
Coaxial Stripper
For RG59/62/6/11/7/213
/8&UTP Round Cables



APC660080
Coaxial & networking Stripper
For RG59/6/7/11 Coaxial cable
&UTP/STP round, flat cable,
With cable cutter



APC660081
Coaxial Cable Stripper
For RG-59/62/6/11/7
/213/8 Cable



APC660073
Easy Coaxial Stripper
Use for RG59/62,6 Cable



APC660074
Coaxial Stripper
with 2 Blades Model
For RG58/59/62/6/6QS/3C/4C/5C



APC660075
Coaxial Stripper
with 3 Blades Model,
For RG58/59/6



APC660082
Networking Stripper UTP/STP,
Flat Cable Stripper & Cutter



APC660083
Coaxial Stripper 2-Blades Model
For RG174/58/59/62/6(Φ2.6-Φ8.0)
& Flat Cable Stripper & Cutter



APC660084
Coaxial Stripper 3-Blades Model
For RG174/58/59/62/6(Φ2.6-Φ8.0)
& Flat Cable Stripper & Cutter

PUNCH DOWN TOOLS

[Http://www.apc-elec.com](http://www.apc-elec.com)



APC660085
Adjusting Cable Slitter
Strip Cables from 4.5-25mm
(.18"-1.0")diameter



APC660086
Adjusting Cable Slitter
Strip Cables from 25-36mm
(1.0"-1.4")diameter



APC660087
Punch Down Tool
with Easy Stripper
For UTP/STP Round Cable



APC660094
Punch Down Tool
With 110 blades



APC660095
Punch Down Tool
A:With 110 blades;
B:With 110&66 blades



APC660096
Punch Down Tool
A:With 110 blades;
B:With 110&66 blades



APC660088
Easy Punch Down Tool
A:Krone type;
B:110 type



APC660089
Punch Down Tool
For Impact Krone Modules
With close lock



APC660090
Punch Down Tool
For Impact Krone Modules



APC660097
Punch Down Tool
With 110 blades



APC660098
Punch Down Tool
With 110 blades



APC660099
Punch Down Tool
IBDN type,With close lock



APC660091
PVC Boot For Krone Tool



APC660092
Punch Down Tool
For Tyco Type Modules,



APC660093
Punch Down Tool
For Impact Krone Modules,
With close lock



APC660100
Punch Down Tool,110 type
A:4 Pairs
B:5 Pairs.



APC660101
Punch Down Tool
Krone type,With close lock



APC660102
Punch Down Tool
For Impact telecom terminal
block,With close lock

PUNCH DOWN TOOLS

PUNCH DOWN TOOLS

[Http://www.apc-elec.com](http://www.apc-elec.com)



APC660103
Punch Down Tool
Use on telecom terminal block



APC660104
Punch Down Tool
For Impact telecom terminal block, With close lock



APC660105
HUAWEI D2 type, Impact Tool
with hook and Screw driver



APC660112
Cable Cutter For cutting 6.5"
cuts wire O.D. UP to .41" (10.5mm)



APC660113
5" Mini Cutting Plier



APC660114
5" Mini Cutting Plier



APC660106
Punch Down Tool
Use on telecom terminal block



APC660107
Punch Down Tool
For Tyco Type Modules,



APC660108
Punch Down Tool
For 3M Type Modules,



APC660115
Self-adjusting Cutter Stripper
For single of multiple cables
section 0.5-6 mm



APC660116
Self-Adjusting Wire Stripper
4 in 1 Wire Cutter & Stripper
Easy to strip and cut the wire.
One lock control open and close.
Easy and quick operate.
Strip size: 10, 12, 14, 16, 18, 20, 22AWG



APC660117
Precision stripper
6.6" 5 in 1, precise cutter & stripper
with comfortable thickness handle.
Wire stripper, wire cutter, steel wire
cutter, pliers, wire loop with grinding
blades for sharp cutter & stripper, wire
stripper with ergonomically designed handles.
Laser marked gauges including AWG & mm
Wire stripping size: 10, 12, 14, 16, 18, 20, 22AWG,



APC660109
Punch Down Tool
For 3M Type Modules



APC660110
Punch Down Tool
For 3M Type Modules



APC660111
Punch Down Tool
For Impact telecom terminal



APC660118
Cable Cutter 7.05"
For cutting cable RG58, RG59 and Rg6,
cable could contain the steel component.
With an additional safe guard function.



APC660119
Precision Wire Stripper
6.6" 5 in 1, precise cutter & stripper
with comfortable thickness handle.
Made by CNC grinding
Laser marked gauges including AWG & mm.
stripping size: 12, 14, 16, 18, 20, 22AWG,
Copper wire only.



APC660120
Clamper
Stripping 24-12AWG wire
Cutting Cu, 1 soft wire
Cutting bolt 4-40, 6-32, 10-24, 10-32
(inch size)
Cutting 3mm steel wire
Crimping ins terminals 16-10AWG
Crimping non-ins, Terminals 22-18AWG,
Crimping ignition terminals 7-8mm

STRIPPER TOOLS



APC660121
Wire stripper&Cable Cutter
Sharp edge cutting wire.
Multi location for reel wire high precise design of milling edge.
Multi purpose tool 10 functions in 1, stripping size:8,10,12,14AWG, Cutting cable:RG58,RG59&RG6.



APC660122
Automatic wire stripper & crimper
Easy stripping without adjustment.
Multifunction made of steel by special hardened.
Stripper range:(0.2-6MM²) 10-24AWG,
For insulated terminals 22-10AWG(0.2-6MM²)
For non-insulated terminals 22-10AWG(0.2-6MM²)
For auto ignition terminal 7-8mm.



APC660123
Cable Stripping 8-28mm
With hook blade for stripping flat cable



APC660130
modular plug crimping tool RJ45/11/9
punch down tool with 110
wire stripper
cable tester
screwdriver (+/-)102X100mm
modular plug
plastic box



APC660124
Optic Fiber Stripper
For stripping 250 micron buffer coating to expose 125 micron fiber,
Second hole for stripping 2-3mm fiber jackets.



APC660125
Optic Fiber Stripper
New developed precision blade cutter made micro blade hole possible,
Unlike conventional wire stripper, high carbon alloy steel guarantees longer life with such accurate stripping.
Non-play Fulcrum(joint)keeps the accuracy of stripping diameter.



APC660126
Automatic Optic Fiber Stripper
For stripping 250 micron buffer coating to expose 125 micron fiber,
Second hole for stripping 2-3mm fiber jackets.

APC660131
soldering iron 30w
desoldering pump
cable tester
professional crimping tool
modular plug crimping plier RJ45/11
screwdriver set
tweezers
knife
7 in 1 wire stripper & wire cutter
mini cutting plier
long nose plier 5"
wire stripper
precision screwdriver(+/-) 3X75mm
solder



APC660127
Fiber Optic Stripping Tool
Three stripping guides for 2mm outer jacket,900um butter insulation 250um butter



APC660128
Fiber Optic Cutting Tool



APC660129
Optic Fiber Stripper
Make stripping more convenient
Sharp blade to make cutting easier,
Adjustable to make stripping more accurate.



APC660132
7 pcs folding type hex key wrench
4.5" minicutting plier
Network cable tester
Desoldering pump
Professional modular plug crimping tool
Coaxial wire stripper
Network cable stripper
5 in 1 precision screwdrivers
Tweezers
6" long nose plier
PLCC extractor
30W soldering iron
Impact and punch down tool
Professional crimping tool
Utility component storage box
2pcs crystal screwdrivers
2M/6ft tape measure
Solder



APC660133
 Voltage tester
 Mini cutting plier
 6" Long nose plier
 Desoldering pump
 Soldering iron
 7pcs folding type hex key wrench
 Tweezer
 PLCC extractor
 Cable tester
 Professional crimping tool
 Professional Modular plug crimping tool
 Punch down tool
 Coaxial wire stripper
 Network cable stripper
 5 in 1 precision screwdriver
 2M/6ft measure tape
 Solder
 Color screwdrivers
 Philips:5x75mm
 Slotted:5x75mm



APC660136
 TOOL KITS
 LY-T2016 Crimping Tool for RJ45/RJ12/RJ11
 LY-T501A Wire Stripper RJ45/RJ11
 LY-US005 Moduler Plug RJ45:30pcs
 LY-US002 Moduler Plug RJ11:30pcs



APC660137
 TOOL KITS
 LY-T2016 Crimping Tool for RJ45/RJ12/RJ11
 LY-T2024 Punch Down 110 Type
 LY-T501A Wire Stripper RJ45/RJ11
 LY-US005 Moduler Plug Rj45:30pcs
 LY-US002 Moduler Plug Rj11:30pcs

APC660134
 Telephone crimping tool
 Punch down tool with 110/66 blades
 4.5" diagonal cutting plier
 Cable cutter
 Coaxial wire stripper
 Voltage test
 6pcs electronic screwdriver set
 IC extractor
 6" adjustable wrench
 5 in 1 precision screwdrivers
 7 in 1 wire stripper & wire cutter
 4.5" long nose plier
 Network cable tester
 Precision tweezers
 30W soldering iron
 Desoldering pump
 Color screwdrivers
 Philips:5x75mm
 Slotted:5x75mm
 3 prong holder
 2M/6ft measure tape
 Solder



APC660138
 TOOL KITS
 LY-T568R Crimping Tool for RJ45/RJ12/RJ11
 LY-CT005 Cable Tester RJ45/RJ12/RJ11
 LY-T501A Wire Stripper RJ45/RJ11
 LY-US005 Moduler Plug RJ45:30pcs
 LY-US002 Moduler Plug RJ11:30pcs



APC660139
 TOOL KITS
 LY-T236A Crimping Tool for RG58/RG58/RG62/RG174
 LY-T206 Cable Cutter For cutting 6.5"
 LY-T332 Coaxial Stripper RG58/59/62/6
 4 Pcs Die Set (336C/336GG/336J/336K)



APC660135
 7 in 1 wire stripper&wire cutter
 4.5" diagonal cutting plie
 4.5" long nose plier
 6" stainless scissors
 Network cable tester
 Punch down tool with 110/66 blades
 6" adjustable wrench
 coaxial wire stripper
 knife
 professional crimping tool
 Waterproof F plug compression tool
 Professional modular plug crimping tool
 Utility component storage box
 Color screwdrivers
 Philips:5x75m
 Slotted:5x75mm



APC660140
 Professional crimping tool
 4PCS die set
 Punch down tool
 65" Cable cutter or wire diameter up to 105mm
 Wire stripper RG58/59/62
 Voltage tester
 Components storage box
 Utility knife
 6" Diagonal plier
 6" Long nose plier
 30W Soldering iron
 Desoldering pump
 7pcs folding type hex key wrench
 Screwdriver set
 Cushion grip nut driver screwdriver set
 Solder
 25pcs super torque ratchet driver set includes
 Changeable shank ratchet driver
 Philips shanks; #0,1,2,3
 Slotted bit shanks; 1/8", 3/16", 1/4"
 Star bit shanks; T10, T15, T20, T25, T27, T30
 Socket adaptor

APC660141

Component storage box
 Professional crimping tool
 Punch down tool with 110/66 blades
 Mini cutting plier
 Mini cutting plier
 5" Diagonal cutting plier
 Coaxial cable stripper RJ 58/59/62/6
 Anti-static wrist strap
 Blowing brush
 5" Long nose plier
 7 in 1 wire stripper & wire cutter
 Desoldering pump
 6" stainless scissors
 soldering iron
 Network Tester
 Digital multimeter
 Torx: T6, T7, T8, T9, T10, T15
 Super torque ratchet handle
 12pcs screwdriver blades
 Slotted: 3, 5, 6mm
 6pcs Hex drivers w/1/4
 (3/32", 1/8", 5/32")
 (3, 4, 4.5, 5, 5.6mm)
 Modular Plug RJ-45/12/11, RG58/59/62
 Inspection mirror
 Mini flash light
 Solder
 ABS Tool-carrying case(435x310x140)



APC660142

TOOL KITS
 wire cutter/stripper
 diagonal cutting plier
 long nose plier
 6" adjustable wrench
 solder 10g
 Antistatic chip inserter
 Antistatic three prong chip retriever
 soldering iron
 Extra parts tube
 3/16" nut driver
 1/4" nut driver
 heavy duty screwdriver reversible #1/4"
 heavy duty screwdriver reversible T10/T15 torx
 (+)3/16" slotted screwdriver
 (+)3/16" slotted screwdriver
 (-)1/8" slotted screwdriver
 (+)1/8" slotted screwdriver
 antistatic chip tweezer
 release hold tweezer



APC660143

Lone nose plier 150mm
 mini cutting plier 150mm
 7in 1 wire stripper & wire cutter
 telephone plier RJ45/12/11
 punch down tool with 110/66 blade
 mini wire stripper
 soldering iron 30w
 cable tester
 tweezers 125mm
 tapeline 2m/6ft
 knife
 crystal screwdrivers(-)5X100/6X125mm
 crystal screwdrivers(+)-5X100/6X125mm
 modular plug rj45X6pcs
 plastic box 315X255X55mm

APC660144

Professional coaxial tool
 Wire stripper RJ 58/59/62
 Network cable tester
 Punch down tool 110 blade/66 blade
 RG59, RG6
 (+)101x75mm
 245x410x65mm



APC660145

Moduler plug crimping plier RJ45/11
 Long nose plier 6"
 Coaxial cable stripper RJ58/59/62/6
 7 in 1 wire stripper & wire cutter
 (8P8C/6P6C/4P4C)
 (+)102x125mm
 245x410x65mm

LY-TK16



Use for Moduler plug RJ45/RJ11/RJ9

LY-TK19



Use for Moduler plug RJ45/RJ11



APC660146
 Moduler plug crimping plier RJ45/12/11
 Wire stripper RJ 58/59/62
 Cable tester
 Punch down tool 110 blade/66 blade
 (8P8C/6P6C/4P4C)
 (+)101x75mm
 245x410x65mm



APC660149
 Coaxial wire stripper RG 58/59/62
 Professional crimping tool
 Cable cutter
 4pcs die set
 Screwdriver*+ *102x100mm
 Plastic box 315x255x55mm



APC660150
 Moduler plug crimping plier RJ45/12/11
 Wire stripper RJ 58/59/62
 Punch down tool 110 blade/66 blade
 (8P8C/6P6C/4P4C)
 (+)101x75mm
 245x410x65mm



APC660147
 Wire stripper RJ58/59/62/6
 Punch down tool
 Telephone plier RJ-45/12/11
 Blade
 Moduler plug 8P8C, 6P6C
 Add EVA foam insulate plug
 Plastic box 315x255x55mm



APC660148
 Professional crimping tool
 Punch down tool
 Moduler plug crimping tool RJ45/12/11
 Blade
 Die set 3pcs
 Screwdrivers(+) 104x38mm
 Moduler plug RJ45 3PCS
 Plastic box 315x255x55mm



APC660151
 BNC crimping plier
 Coaxial cable stripper RJ 58/59/62/6
 Cable cutter
 4pcs die set
 Screwdriver(+)*102x100mm
 Plastic box 245x410x65mm



APC660152
 TOOL KITS
 LY-T2007C Crimping Tool for RJ45//RJ11/RJ9
 LY-T501A Wire Stripper RJ45/RJ11
 LY-CT027 Cable Tester RJ45/RJ11
 LY-T2017 Punch Down Tool With Easy Stripper
 Screwdriver (-)2.4X20MM, (+)0#X20MM
 LY-US005 Moduler Plug RJ45 : 6pcs



APC660153
TOOL KITS
Connector Kit for Rg6 Quad
Shield Coaxial Cable



APC660154
TOOL KITS
LY-T2006C Crimping Tool for RJ45//RJ11
LY-T3141 Punch Down 110&66 Type
LY-CT006 Cable Tester RJ45/RJ11/BNC
LY-T2017 Wire Stripper For Round Cable
LY-US005 Modular Plug RJ45 : 10pcs
LY-US015 PVC Boot : 10pcs



APC660157
TOOL KITS
LY-T2007C Crimping Tool for RJ45//RJ11/RJ9
LY-T2021 Punch Down Krone Type
LY-CT007 Cable Tester RJ45/BNC
LY-T501A Wire Stripper RJ45/RJ11
LY-US005 Modular Plug RJ45 : 10pcs
LY-US015 PVC Boot : 10pcs



APC660158
Modular plug crimping plier
Punch down tool
Coaxial & Network cable stripper
Professional USB/LAN /9 Multi-modular Cable Tester
Connection line 2pcs
Connection 1pcs
Network plug 8p8c 10pcs 6p6c 10pcs



APC660155
Modular plug crimping plier RJ45/12/11
Punch down tool
Wire stripper RG58/59/62
Lan Multi-network cable tester
Connectors 1pcs
Connecting line 2pcs
Network plugs 8p8c 10pcs 6p6c 10pcs



APC660156
Modular plug crimping plier Rj45
Punch down tool
Wire stripper RG58/59/62
Lan Multi-net work modular cable tester



APC660159
Stripping tool
Multi-function Stripper/Cutter
for Network UTP/STP wire or cable
from 3.2mm to 9mm
Multi-functional network cable tester
Network tool designed for 8P8C, 6P6C & 4P4C with
crimping/cutting stripping 3in 1 function





APC660160
 Cable stripper for rg58/59/6/3C/4C/5C
 Cable cutter
 Crimping tool for F connectors Crimping tool for RG59,RG6
 With 6pcs "F" plug connectors available



APC660161
 Professional network crimping tool 8p8c,6p6c
 Enhanced cable tester
 Network plugs 8P8C 10pcs 6P4C 10pcs



APC660164
 Cable stripper for RG58//59/62/6/3C/4C/5C
 Cable cutter
 Crimping tool for F connectors
 Crimping tool for RG59,RG6
 5pcs "F" plug connectors available



APC660165
 Coaxial cable stripper(2-blade model)
 The inner blade is used for RG58,RG59,coaxial cable
 Precise cutter and stripper
 3 in 1 multi-functional network plier with cutting,
 stripping and crimping functions
 Precise cutter&stripper
 Punch down tool
 Professional ratchet type crimping tool
 and 4pcs types terminal
 Crystal line color screwdriver(+102x75mm)
 Network cable tester



APC660162
 Multi-funtional compression tool
 Cable cutter
 Cable stripper works for RG59/6,RG7/11
 2pcs screwdriver
 Connectors 6psc



APC660163
 Series modular head crimping tools with 5 heads selectable
 Cable cutting plier
 1pc mini screwdriver 6x38mm



APC660166
 Crimping Tools Set
 Cable stripper for RG58/59/62/6/3C/4C/5C
 Cable cutter
 Crimping tool for F connectors (RG59,RG6)
 Double holder for tools



APC670001
UTP Cat5 Patch Cord
RJ45 To 2x2pairs Patch Plug



APC670002
UTP Cat5 Patch Cord
RJ45 To 4pairs Patch Plug



APC670007
10 Pairs LSA Module
A:10 Pairs Disconnection Module
B:10 Pairs Connection Module



APC670008
10 Pairs LSA Module
A:10 Pairs Disconnection Module
B:10 Pairs Connection Module



APC670003
UTP Cat5 Patch Cord
4pairs-2*2pairs Patch Plug



APC670004
UTP Cat5 Patch Cord
4pairs-4pairs Patch Plug



APC670009
10 Pairs Profile Module
A:10 Pairs Disconnection Module
B:10 Pairs Disconnection Module

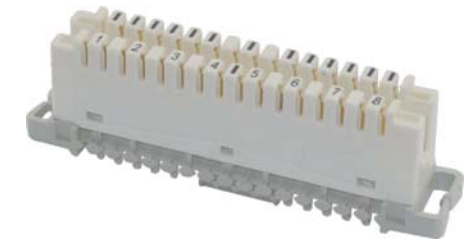

APC670010
8 Pairs LSA Module
A:8 Pairs Disconnection Module
B:8 Pairs Connection Module



APC670005
Cat3 Patch Cord
1pair To 1pair Patch Plug

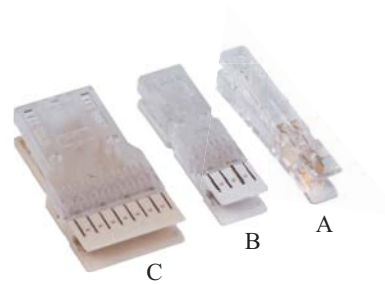

APC670006
110 Patch Plug
1/2/4 Pairs

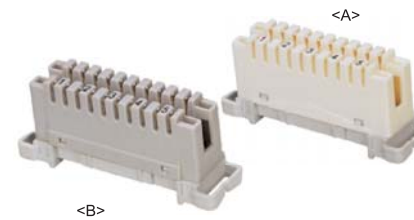

APC670011
5 Pairs Disconnection & Connection Module
A:5 Pairs Disconnection Module
B:5 Pairs Connection Module



APC670012
5 Pairs Disconnection Module
Surface Mount Type



APC670013
10 Pairs Profile Highband
Disconnection Module



APC670014
8 Pairs Profile Highband
Disconnection Module



APC670019
Profile disconnection module 2/6x3
Dimension:124x21x40mm

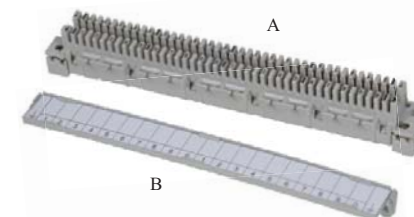

APC670020
20 Pairs Connection Module
A: 20 Pairs Connection Module
B: Label For 20 Pairs Connection Module



APC670015
10 Pair disconnection module with PCB
Dimension:128x37x36mm



APC670016
10 Pair disconnection module for PCB
Dimension:138x21x35mm

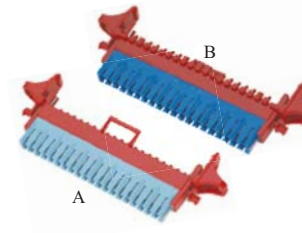

APC670021
10 Pairs Module(Pouyet Type)
A:10 Pairs Disconnection Module
B:10 Pairs Connection Module

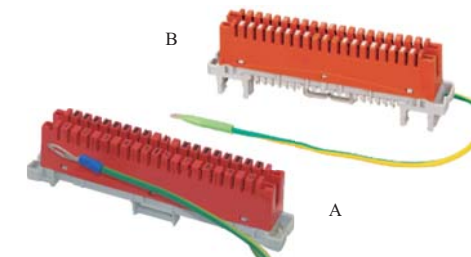

APC670022
10 Pairs Earth Module
A: For 10 Pairs Mounting Frame
B: For 10 Pairs Profile Frme



APC670017
16Pair LSA disconnection module
Dimension:140x22x40mm



APC670018
LSA disconnection module 2/6x3
Dimension:124x21x40mm

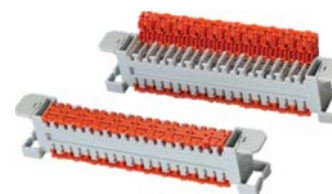

APC670023
10 Pairs Module
Toolless Type For Wire Connection



APC670024
8 Pair LSA disconnection module 2/8x3
With wire guide and lable holder, metal bracket.
Dimension:150x30x47mm.



APC670025
25 Pairs Feed Through Module
Internal Diameter Of Wire: 0.4mm -0.65mm



APC670026
2 Pole Arrestor Magazine
For 10 Pairs LSA Module,



APC670031
Label Holder
For 8 Pairs Mounting Frame



APC670032
Label Holder
For 10 Pairs Mounting Frame



APC670027
3 Pole Arrestor Magazine
For 10 Pairs LSA Module

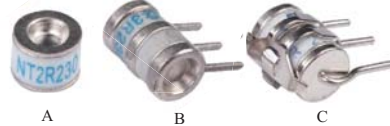

APC670028
Gas Discharge tube
A:2 Electrode, 230V, 8x6mm
B:3 Electrode, 230V, 7.5x12mm
C:3 Electrode, With Fail Safe, 230V, 7.5x12mm



APC670033
Label Holder
For 10 Pairs Profile Frame



APC670034
Low Label Holder
For 10 Pairs Profile Frame

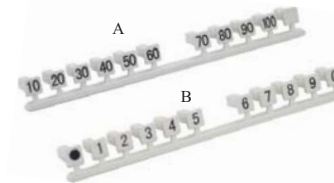

APC670035
Number Flags
A: Printer 1-0
B: Printer 10-100

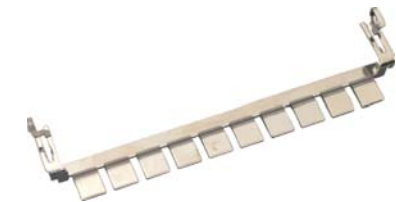

APC670036
Earth Bar
For 10 Pairs Module



APC670029
Hinged Label Holder
For 10 pairs Module



APC670030
Hinged Double-side Label Holder
A: For 10 pairs Module
B: For 8 pairs Module



APC670037
Earthing Line
For LSA Profile Module



APC670038
C Type Disconnection Plug
For C Type Terminal Block



APC670039
Disconnection Plug
For 10 Pairs Disconnection Module

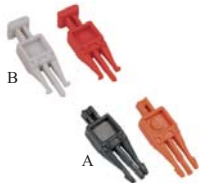

APC670040
1 Pair Disconnection Plug
A:Faking Disconnection Plug
B:Natural Disconnection Plug



APC670041
Lightning Protector Unit
With 3P Arrester(DC Spark-over Voltage:230V)
With LED Light



APC670042
Lightning Protector Unit
With 3P Arrester
(DC Spark-over Voltage:230V)



APC670052
10 Pair Indoor Distribution Box
With 10 pair LSA modules
Dimension:165x65x55mm



APC670053
20 Pair Indoor Distribution Box
With 2Pcs 10 pair LSA modules
Dimension:170x120x40mm



APC670054
30 Pair Indoor Distribution Box
For 10 pair LSA modules
Dimension:150x105x55mm



APC670043
Cat.5e test cord
4 Pole test plug and 8p4c plug.
Cable length: 1.5m



APC670044
2 Pole test cord
2 Pole test plug and 6p2c plug.
Cable length: 1.5m



APC670045
4 Pole test cord
4 Pole test plug and 6p4c plug.
Cable length: 1.5m



APC670055
30 Pair Indoor Distribution Box
For 10 pair LSA modules
Dimension:180x170x75mm



APC670056
50 Pair Indoor Distribution Box
For 10 pair LSA modules
Dimension:205x190x105mm



APC670057
100 Pair Indoor Distribution Box
For 10 pair LSA modules
Dimension:275x205x105mm



APC670046
2 Pole test cord
Double test plug
Cable length: 1.5m



APC670047
4 Pole test cord
Double test plug
Cable length: 1.5m



APC670048
2 Pole test cord
With 2 pcs alligator plugs
Cable length: 1.5m



APC670049
4 Pole test cord
With 4 pcs alligator plugs
Cable length: 1.5m



APC670050
Nortel Wiring Block
25 Pair Wiring Block



APC670051
Nortel Wiring Block Metal Frame
A:50 Pair Metal frame With Bracket
B:100 Pair Metal frame With Bracket



APC670058
30 Pair Indoor Distribution Box
For 10 pair LSA modules
Dimension:171x140x75mm



APC670059
50 Pair Indoor Distribution Box
For 10 pair LSA modules
Dimension:209x209x75mm



APC670060
100 Pair Indoor Distribution Box
For 10 pair LSA modules
Dimension:320x215x75mm

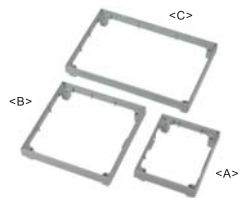

APC670061
Plastic Frame For Distribution Box
A:Frame For 30 Pairs Box
B:Frame For 50 Pairs Box
C:Frame For 100 Pairs Box

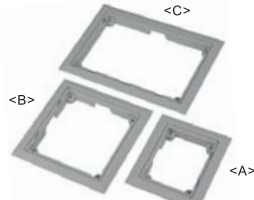

APC670062
Plastic Frame For Distribution Box
A:Frame For 30 Pairs Box
B:Frame For 50 Pairs Box
C:Frame For 100 Pairs Box



APC670063
300 Pair Indoor Distribution Box
For 10 pair LSA modules



APC670070
30Pair Outdoor Distribution Box
For 10 pair LSA modules



APC670071
50Pair Outdoor Distribution Box
For 10 pair LSA modules



APC670072
100Pair Outdoor Distribution Box
For 10 pair LSA modules



APC670064
30Pair Indoor Distribution Box
For 10 pair LSA modules



APC670065
50Pair Indoor Distribution Box
For 10 pair LSA modules



APC670066
100Pair Indoor Distribution Box
For 10 pair LSA modules



APC670073
20Pair Indoor Metal Distribution Box
For 10 pair LSA modules

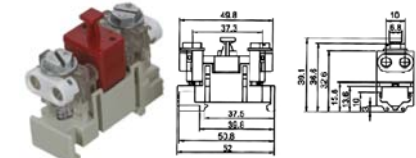

APC670074
1Pair Quick-connect Subscriber
Terminal Block With Protection
Conductor Diameter: 0.4-1.2mm.
Overall insulation diameter: 0.5mm max.
Mounted exchange tube inside for protection.



APC670067
30Pair Outdoor Distribution Box
For 10 pair LSA modules



APC670068
100Pair Outdoor Distribution Box
For 10 pair LSA modules



APC670069
10Pair Outdoor Distribution Box
For 10 pair LSA modules

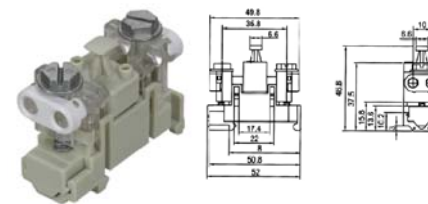

APC670075
1Pair Quick-connect Subscriber
Terminal Block Without Protection
Conductor Diameter: 0.4-1.2mm.
Overall insulation diameter: 0.5mm max.



APC670076
1 Pair Distribution Box
For STB Module



APC670077
2 Pair Distribution Box
For STB Module



APC670078
2 Pair Distribution Box
For STB Module



APC670079
4 Pair Distribution Box
For STB Module



APC670085
19" 1U 60 pair Backmount Frame
For 10 pair LSA modules



APC670086
19" 2U 90 pair Backmount Frame
For 10 pair LSA modules



APC670087
19" 3U 150 pair Backmount Frame
For 10 pair LSA modules



APC670088
19" 180 4U pair Backmount Frame
For 10 pair LSA modules



APC670080
10 pair distribution box
For STB Module



APC670081
10 Pair Pouyet Type Distribution Box
For STB Module



APC670082
10 Pair Distribution Box
For STB Module



APC670089
19" 4U 180 pair Backmount Frame
For 10 pair LSA modules



APC670090
19" 3U 150 pairs Back Mount Frame
For 10 pair LSA modules



APC670083
20 Pair Distribution Box
For STB Module



APC670084
10 Pair Distribution Box
For STB Module



APC670091
19" 3U 150 pairs Back Mount Frame
For 10 pair LSA modules



APC670092
19" 2U 96 Pairs Mounting Frame
For 8 Pair LSA Profile Module.



APC670093
19" 1U 30 pair Backmount Frame
For 10 pair LSA modules



APC670094
19" 1U 60 pair Backmount Frame
For 10 pair LSA modules



APC670095
19" 3U 180 Pairs Mounting Frame
For 10 Pair LSA Profile Module.



APC670096
19" 3U 200 pairs Back Mount Frame
For 10 pair LSA modules



APC670097
10" 1U 10 pair Backmount Frame
For 10 pair LSA modules



APC670098
Back Mount Frame
For 8Pair Or 10Pair LSA Module
1/2/3/5/10...Ways.



APC670099
Back Mount Frame
For 10Pair LSA Module
1/2/3/5/10...Ways.



APC670100
100 pairs Back Mount Frame
For 10 pair LSA Modules



APC670101
100 pairs Back Mount Frame
For 10 Pair LSA profile module.

Lock Joint Connectors & 25 Pairs Splicing Module

Photo	Termination	Insulation	Conductor	Item No
		1.52mm	0.4-0.9mm	LY-TM042-UY2
		1.52mm	0.4-0.7mm	LY-TM042-UY
		1.67mm	0.4-0.9mm	LY-TM042-UR
		1.67mm	0.4-0.9mm	LY-TM042-UG
		2.0-3.3mm	Iron 1.2-1.5mm	LY-TM042-U1B
		1.67mm	0.4-0.9mm	LY-TM042-UB
		1.52mm	0.4-0.7mm	LY-TM042-KT10
		25Pairs Splicing Module(400-D type)		LY-TM096



APC680001
Wall Mounted F/O Distribution Box
For 6/8/12 pcs SC/ST Aaptor



APC680002
19" 1U Fiber Optical Patch Panel
For 12/24 pcs ST/SC/FC Adaptor



APC680007
19" 1U Fiber Optical Patch Panel
For 24 pcs SC/ST/FC Adaptor



APC680008
19" 1U Fiber Optical Patch Panel
For 12 pcs SC/ST/FC Adaptor



APC680003
Wall Mounted Fiber Optical Distribution Box
For 12/24 pcs ST/SC/FC Adaptor



APC680004
Wall Mounted Fiber Optical Distribution Box
For 48 pcs ST/SC/FC Adaptor



APC680009
19" 1U Fiber Optical Patch Panel
For 24 pcs SC/ST/FC Adaptor



APC680010
19" 2U Fiber Optical Patch Panel
For 24 pcs SC/ST/FC Adaptor



APC680005
19" 1U Fiber Optical Patch Panel
For 12/24 pcs ST Adaptor

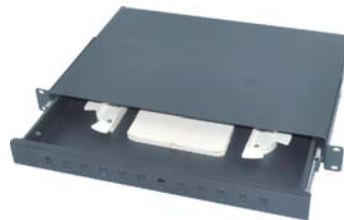

APC680006
19" 1U Fiber Optical Patch Panel
For 12/24 pcs SC Adaptor



APC680011
19" 1U Fiber Optical Patch Panel
For 24 pcs SC/LC Adaptor

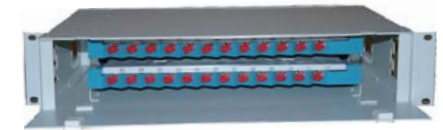

APC680012
19" 24 Cores Fiber Optical Patch Panel
For 24 pcs FC/SC adaptor



APC680013
Full-seal SC/ST/FC FO panel
APC680014
Full-seal Duplex SC FO panel



APC680015
FO panel with changeable panel
3pcs panel(ST,SC,DUPLEX SC,FC)changeable



APC680016
48 Core Duplex SC patch panel
With panel for 24pcs Duplex SC adaptor



APC680024
FTTH Fiber Optic Termination Box For 12C
Dimension:234X206X64MM
Outside type, protection grade: IP5



APC680025
FTTH Fiber Optic Termination Box For 24C
Dimension:350X340X100MM
Outside type, protection grade: IP53



APC680017
Full-sealed fiber optic patch panel
ST,SC,FC,Duplex SC or blank for changeable



APC680018
Sliding fiber optic patch panel
2pcs panel(ST,SC,DUPLEX SC,FC)changeable



APC680019
2 Cores FTTH box
For 2 x SC adaptor
Size:86X86mm



APC680026
FTTH Fiber Optic Termination Box For 24C
Dimension:330X225X90MM
Outside type, protection grade: IP5



APC680027
FTTH Fiber Optic Termination Box For 48C
Dimension:420X320X132MM
Outside type, protection grade: IP53



APC680020
FTTH box For SC,FC adaptor
Cores: Max. up to 4 cores
Size:200x135x42mm



APC680021
FTTH box For SC,LC adaptor
Cores: Max. up to 8 cores
Size:240x195x66mm



APC680022
FTTH box
Widely used in FTTH access network
Accomodate 1x8 & 1x16 PLC splitter
Cores: Max. up to 16 cores
Used for outdoor
Szie:302x224x91mm



APC680023
FTTH box
Widely used in FTTH access network
Accomodate 1x8 & 1x16 PLC splitter
Cores: Max. up to 16 cores
Used for outdoor
Szie:306x240x106mm



APC680028
FTTH Fiber Optic Termination Box For 24C
Dimension:340X265X126MM
Outside type, protection grade: IP53



APC680029
FTTH Fiber Optic Termination Box For 16C
Dimension:300X224X92MM
Outside type, protection grade: IP5



APC680030
FTTH Fiber Optic Termination Box
Dimension:131X84X24MM



APC680031
FTTH Fiber Optic Termination Box
Dimension:150X110X34MM



APC680032
FTTH Fiber Optic Termination Box
Dimension:265X155X54MM



APC680033
FTTH Fiber Optic Termination Box
Dimension:186X110X43MM



APC680034
FTTH Fiber Optic Termination Box
Dimension:157X119X34MM



APC680035
FTTH Fiber Optic Termination Box
Dimension:160X80X37MM



APC680036
24 core fiber optic splicing tray



APC680037
12 core fiber optic splicing tray



APC680038
12 core fiber optic splicing tray



APC680039
24 core fiber optic splicing tray



APC680040
12 core fiber optic splicing tray



APC680041
Fiber Splice Cassette
For 12/24 fusion splice,



APC680042
Uprturned fiber optic splicing tray



APC680043 40mm splicing sleeve
APC680044 50mm splicing sleeve
APC680045 60mm splicing sleeve

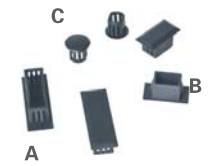

APC680046 For Duplex SC hole
APC680047 For SC/FC hole
APC680048 For ST hole

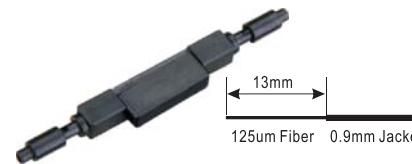

APC680049
Universal optical fiber splice



APC680050
Mechanical splice



APC680051
Specification D*D(mm): 435*Φ190
Cable Ports: 4
Capacity Bunchy Fiber: 12F-96F



APC680052
Specification D*D(mm): 415*Φ190
Cable Ports: 4
Capacity Bunchy Fiber: 12F-96F



APC680058
Specification L*W*H(mm): 410*200*120
Cable Ports: 6
Capacity Bunchy Fiber: 12F-96F



APC680059
Specification L*W*H(mm): 450*216*110
Cable Ports: 8
Capacity Bunchy Fiber: 12F-96F



APC680052
Specification D*D(mm): 390*Φ190
Cable Ports: 4
Capacity Bunchy Fiber: 12F-96F



APC680053
Specification D*D(mm): 455*Φ220
Cable Ports: 7
Capacity Bunchy Fiber: 12F-96F



APC680060
Specification L*W*H(mm): 450*216*110
Cable Ports: 6
Capacity Bunchy Fiber: 12F-96F



APC680061
Specification L*W*H(mm): 450*216*160
Cable Ports: 6
Capacity Bunchy Fiber: 12F-96F



APC680054
Specification D*D(mm): 540*Φ205
Cable Ports: 5
Capacity Bunchy Fiber: 24F-96F



APC680055
Specification D*D(mm): 288*Φ178
Cable Ports: 4
Capacity Bunchy Fiber: 6F-48F



APC680062
Specification L*W*H(mm): 280*200*90
Cable Ports: 2
Capacity Bunchy Fiber: 12F-96F



APC680063
Specification L*W*H(mm): 456*200*110
Cable Ports: 4
Capacity Bunchy Fiber: 12F-144F



APC680056
Specification D*D(mm): 455*Φ220
Cable Ports: 7
Capacity Bunchy Fiber: 24F-288F



APC680057
Specification D*D(mm): 455*Φ220
Cable Ports: 6
Capacity Bunchy Fiber: 12F-48F



APC680064
Specification L*W*H(mm): 430*180*125
Cable Ports: 6
Capacity Bunchy Fiber: 12F-96F